



TORONTO ZOO

**Request for Tenders for
Retaining Wall Replacement**

RFT No.: TZC T 38-2021-10

Contract No.:

Issued: 2021-10-27

**TZC T 38-2021-10
RETAINING WALL REPLACEMENT**

CLOSING DATE: Wednesday, 2021-11-17 at 12:00 p.m. local time

Bids are invited for Retaining Wall Replacement all in accordance with this Request for Tender. This RFT is posted on the Toronto Zoo web site at <http://www.torontozoo.com/business>

SUBMISSION

- 1.1 Submission – Temporary process - In view of the current situation with COVID 19 and to limit personal interaction, on a temporary basis submission for this Request for Proposal can be submitted electronically by email in a PDF file, prior to the submission deadline to the following email address

bids@torontozoo.ca

and note the following:

- a. Subject of the file to be: **RFT# - Title of RFT – Vendor name.**
- b. Amendments to a Proposal may be submitted via the same methods, at any time prior to the Closing Time.
- c. It is the Supplier's sole responsibility to ensure its Bid is received by the Submission Deadline in accordance with the requirements of this RFQ. The receipt of Bids can be delayed due to a number of factors including "internet traffic", file transfer size and transmission speed. The Supplier should allow sufficient time to download, complete and upload, as applicable, the submission forms comprising its Bid and any attachments.

A Bid will only be considered to be submitted once it has been received by the Toronto Zoo. The time of such receipt is reflected by the time received stamped by the Toronto Zoo's email application

QUESTIONS REGARDING THIS RFT

Questions regarding this RFT must be submitted in writing only to Peter Vasilopoulos, Supervisor, Purchasing & Supply no later than **Wednesday, 2021-11-10 at 4:00 p.m. local time**). Questions received later than this stated time and date may not be acknowledged or answered.

ADDENDA

All addenda to this RFT will be posted on the Toronto Zoo's Bid Opportunities Web Page: <http://www.torontozoo.com/business> . Addenda will not be posted until after the date for questions has closed. It is the Bidder's sole responsibility to check this Web Page to avail themselves of any posted addenda. Quotations submitted that do not include the first page, completed and signed, of all posted addenda will be rejected.

Request for Tender
TZC T 38-2021-10 Retaining Wall Replacement
Part 1 – Instruction to Bidders – Section 1

PART 1: INSTRUCTION TO BIDDERS	1
SECTION 1 - RFT SPECIFIC PROCESS AND SUBMISSION INSTRUCTIONS.....	1
1.1 Introduction	1
1.2 Procurement Contact	1
1.3 RFT Documents	2
1.4 Responding to the RFT and Prohibited Communications.....	3
1.5 RFT Timetable	3
1.6 Site Meetings.....	4
1.7 Addenda	5
1.8 Questions.....	5
1.9 Submission of Bids	6
1.10 Amendment of Bids.....	9
1.11 Withdrawal of Bids.....	9
1.12 Bid Validity Period.....	9
SECTION 2 - EVALUATION, ACCEPTANCE AND EXECUTION	10
2.1 Evaluation.....	10
2.2 Rights of the Toronto Zoo.....	11
2.3 Contract Execution.....	13
2.4 Notification to Other Suppliers	14
2.5 Debriefing.....	14
SECTION 3 - GENERAL RFT TERMS AND CONDITIONS.....	15
3.1 General Process Terms and Conditions	15
3.2 Suppliers Shall Bear Their Own Costs	15
3.3 Limitation of Liability.....	15
3.4 Joint Venture Bids.....	16
3.5 Participation in Multiple Bids.....	16
3.6 Toronto Zoo Materials	16
3.7 Ownership of Bid Materials.....	17
3.8 Failure or Default of Supplier	18
3.9 Trade Agreements	19
3.10 Bid Protest Procedure	Error! Bookmark not defined.
3.11 Supplier Code of Conduct.....	Error! Bookmark not defined.
3.12 Governing Law and Enforceability.....	19

TABLE OF CONTENTS

	Page
3.13 RFT Definitions and Interpretation.....	19
PART 2 – FORM OF CONSTRUCTION AGREEMENT	
PART 3 – DRAWINGS AND SPECIFICATIONS	
PART 4 – SUBMISSION FORMS	
FORM A – SUBMISSION FORM	
APPENDIX I – EXPERIENCE & QUALIFICATIONS FORM	
APPENDIX II – LIST OF SUBCONTRACTORS FORM	
APPENDIX III – STATUTORY DECLARATION FORM	
APPENDIX IV – BID BOND	
APPENDIX V – AGREEMENT TO BOND	
APPENDIX VI – PERFORMANCE BOND	
APPENDIX VII – LABOUR & MATERIAL PAYMENT BOND	
PART 5 – PRICING FORM	

Request for Tender
TZC T 38-2021-10 Retaining Wall Replacement
Part 1 – Instruction to Bidders – Section 1 – RFT SPECIFIC PROCESS AND SUBMISSION INSTRUCTIONS

PART 1: REQUEST FOR TENDERS PROCESS

SECTION 1 - RFT SPECIFIC PROCESS AND SUBMISSION INSTRUCTIONS

1.1 Introduction

- .1 This RFT is an invitation by the Toronto Zoo to install retaining wall, and:
 - .1 **to prospective Suppliers to submit bids for the performance of the Work, as further described in Part 3 (DRAWINGS AND SPECIFICATIONS) and the Contract (the "Project").**
- .2 This RFT shall be interpreted in accordance with Section 3.123.3.12 (Governing Law) and 3.13 (RFT Definitions and Interpretation).
- .3 Invitation to submit a Bid, including participation in any pre-qualification, request for information or other similar process or exchange of information prior to the RFT, does not imply that a Supplier is automatically prequalified to meet the requirements of the RFT or that the factors which were examined during such process or exchange may not be re-examined or re-evaluated by the Toronto Zoo during the consideration and selection process for this RFT. It will still be necessary for the Supplier to demonstrate its qualifications through the RFT process.
- .4 The Successful Supplier will be required to execute the Contract with the Toronto Zoo for the provision of the Work. Suppliers should review the terms and conditions set out in Part 2 (FORM OF CONSTRUCTION AGREEMENT) to understand the Contract being entered into with the Toronto Zoo.

1.2 Procurement Contact

- .1 The contact Person at the Toronto Zoo for all matters related to the RFT process (the "**Procurement Contact**") is set out below:

Name and Title
Name: Peter Vasilopoulos Title: Supervisor, Purchasing & Supply Email: pvasilopoulos@torontozoo.ca

- .2 All communications relating to this RFT must be submitted to the Procurement Contact and only communications received by the Procurement Contact will be considered in the RFT process.
- .3 All permitted communications with the Procurement Contact will be deemed as having been received by the Procurement Contact on the dates and times

Request for Tender

TZC T 38-2021-10 Retaining Wall Replacement

Part 1 – Instruction to Bidders – Section 1 – RFT SPECIFIC PROCESS AND SUBMISSION INSTRUCTIONS

1.3 RFT Documents

.1 This RFT is comprised of the following documents:

Part 1 – Request for Tender Process

Section 1 – RFT Process and Submission Instructions;

Section 2 – Evaluation, Acceptance and Execution;

Section 3 – Other RFT Terms and Conditions;

Part 2 – Form of Construction Agreement;

Part 3 – Drawings and Specifications;

Part 4 – Submission Forms, consisting of:

- Form A - Bid Submission Form;
- Appendix I - Experience and Qualifications Form;
- Appendix II - List of Subcontractors Form;
- Appendix III – Statutory Declaration Form;

Part 5 – Pricing Form; and all Addenda.

.2 Prior to submitting a Bid, Suppliers shall examine all components of the RFT (including all reference documents, appendices, forms and Addenda) and, in accordance with Section 1.8 (Questions) promptly notify the Procurement Contact of any perceived errors, omissions, conflicts, ambiguities or discrepancies in the RFT.

.3 While the Toronto Zoo has used considerable efforts to ensure an accurate representation of information in this RFT, the information contained in this RFT is supplied solely as a guide for Bidders. The information is not guaranteed or warranted to be accurate by the Toronto Zoo, nor is it necessarily comprehensive or exhaustive. Nothing in this RFT is intended to relieve Bidders from forming their own opinions and conclusions with respect to the matters addressed in this RFT.

.4 For clarity, no prequalification documents issued by the Toronto Zoo or prequalification submissions delivered by the Suppliers to the Toronto Zoo shall form a part of the RFT or the Contract.

.5 It shall be the responsibility of each Supplier to acquire, other sources or in person from the Procurement Contact, as specified in the RFT, any document that is referenced or mentioned in this RFT which is not included herein.

Request for Tender

TZC T 38-2021-10 Retaining Wall Replacement

Part 1 – Instruction to Bidders – Section 1 – RFT SPECIFIC PROCESS AND SUBMISSION INSTRUCTIONS

- .6 The failure of any Supplier to acquire, receive or examine any document, form, Addendum, or policy shall not relieve the Supplier of any obligation with respect to its Bid or the Contract. The Toronto Zoo is not responsible for any misunderstanding on the part of any Supplier concerning this RFT or its processes.

1.4 Responding to the RFT and Prohibited Communications

Toronto Zoo website

- .1 The RFT is available only through, the Toronto Zoo website at:
<https://www.toronto.ca/business>

Prohibited Communications

- .2 Suppliers (including potential Suppliers) shall not, and shall cause their representatives not to discuss, disclose or communicate, directly or indirectly, any details pertaining to or in connection with their Bid or this RFT to:
- any employee, official, agent, elected or appointed official or other representative of the Toronto Zoo other than the Procurement Contact; or
 - anyone not specifically involved in their Bid (including, without limitation, any other Supplier),

except as may be authorized in writing by the Procurement Contact Other than the Procurement Contact, no Toronto Zoo representative, whether an official, agent or employee, is authorized to speak for the Toronto Zoo with respect to this RFT. Any Supplier who uses or relies on any representation, information, clarification, correspondence or other communication from any other Toronto Zoo representative does so entirely at the Supplier's own risk and the Toronto Zoo shall not be bound by such representation, information, clarification, correspondence or other communication.

- .3 Without limiting any other provision of this Section 1.4. any attempt by a Supplier to bypass the RFT process may be grounds for rejection of its Bid.

1.5 RFT Timetable

- .1 The Toronto Zoo's currently proposed schedule for each step in the RFT process is set out in below.

Event	Date /Time
Issue Date of RFT	2021-10-27

Request for Tender

TZC T 38-2021-10 Retaining Wall Replacement

Part 1 – Instruction to Bidders – Section 1 – RFT SPECIFIC PROCESS AND SUBMISSION INSTRUCTIONS

Event	Date /Time
Site Visit / Pre-Bid Meeting	By appointment only on 2021-11-03, at 9:00 a.m. local standard time. Bidders are required to pre-register by email, no later than 2021-11-02 at 12:00 p.m. local standard time. Email: pvasilopoulos@torontozoo.ca
Deadline for Questions	No later than 2021-11-10 at 4:00pm local time
Submission Deadline	2021-11-17 at 12:00 hours, 12:00pm local standard time
Bid Validity Period	90 days
Anticipated Award Date	2020-11-22

.2 The Toronto Zoo reserves the right to, in the Toronto Zoo's sole and absolute discretion, at any time:

- revise the RFT schedule, to accelerate, eliminate or postpone any of the dates or times set out in this RFT, including the Submission Deadline;
- to add to, delete or re-order any of the milestones set out in this RFT, at any time; or
- modify the RFT process.

1.6 In the event of an inconsistency or a conflict between the Submission Deadline as displayed in the Toronto Zoo Online Procurement System and the Submission Deadline as indicated in an Addendum, location maintained by the Toronto Zoo (online or otherwise), the Submission Deadline as displayed in the Toronto Zoo Online Procurement System shall take precedence.

1.7 Site Meetings

.1 **Site Meeting**

All Suppliers are encouraged to attend a site meeting to familiarize themselves with the Project and ascertain the full extent of the Work required. The site meeting will take place by appointment only on 2021-11-03, at 9:00 a.m. local standard time at 361A Old Finch Ave, Toronto, ON M1B 5K7. Bidders are required to pre-register by email, no later than 2021-10-19 at 12:00 p.m. local standard time.

.2 No statement or information provided in such meeting by either the Toronto Zoo or the Suppliers will amend any provision of this RFT or the Contract, or may be relied upon by a Supplier in the RFT process or its Bid, except and to the extent such statement or information is later confirmed through the issuance of an Addendum.

Request for Tender

TZC T 38-2021-10 Retaining Wall Replacement

Part 1 – Instruction to Bidders – Section 1 – RFT SPECIFIC PROCESS AND SUBMISSION INSTRUCTIONS

1.7 Addenda

- .1 The RFT may only be amended by Addendum in accordance with this Section 1.7 (Addenda). Prior to the Submission Deadline, the Toronto Zoo may at any time or times modify the RFT in whole or in part through the issuance of an Addenda, if deemed necessary by the Toronto Zoo. Each Addendum shall form an integral part of this RFT.
- .2 All Addenda will be posted on the <http://www.torontozoo.com/business> and Toronto Zoo, the Toronto Zoo is not responsible for any failure of such notice system or for notices not received by Suppliers.
- .3 Suppliers must check the Toronto Zoo's <http://www.torontozoo.com/business> frequently to inform themselves of any posted Addendum. Toronto Zoo. Suppliers shall be wholly responsible for checking and reviewing any posted Addenda and ensuring the completeness of the RFT (as amended) and their Bids (as impacted by such Addenda). The Toronto Zoo is not responsible for any incomplete or incorrect Bids resulting from the issuance of an Addendum or a Supplier's failure to update its Bid in response to an Addendum.
- .4 The Toronto Zoo will make reasonable efforts to issue the final Addendum (if any) in a sufficient time prior to the Submission Deadline to allow Suppliers to submit their Bids. If any Addendum requires substantial amendments to the RFT, the Toronto Zoo may, in its sole and absolute discretion, extend the Submission Deadline.
- .5 Other than documents issued as part of the RFT (including Addenda), the Toronto Zoo shall not be responsible for any explanations, instructions or interpretations even if provided by its actual or purported employees, designees or agents. No oral or written explanations, instructions or interpretations shall modify any of the requirements or provisions of the RFT unless in the form of an Addendum.
- .6 Any reference in this RFT to any document comprising this RFT includes any amendments to such document made in accordance with this Section 1.7 (Addenda).

1.8 Questions

- .1 Prospective Suppliers finding errors, omissions, conflicts, ambiguities or discrepancies in the RFT or having questions, comments or concerns regarding this RFT, its process and related matters ("**Questions**") may submit such Questions to the Procurement Contact using the Toronto Zoo QBD form attached. The Toronto Zoo will make reasonable efforts to respond to Questions received by the deadline for Questions set out in the RFT timetable in Section 1.5 (RFT Timetable). However, the Toronto Zoo shall have no obligation to respond to any or all Questions, and the Toronto Zoo's determination as to whether or not it will respond to any Question shall be in the Toronto Zoo's sole and absolute discretion. The onus is on each Supplier to confirm the Toronto Zoo has received all correspondence from the Supplier.

Request for Tender

TZC T 38-2021-10 Retaining Wall Replacement

Part 1 – Instruction to Bidders – Section 1 – RFT SPECIFIC PROCESS AND SUBMISSION INSTRUCTIONS

- .2 Although it is the Toronto Zoo's practice to make available to all Questions received as well as responses to such Questions: (i) for Questions of an administrative nature; or (ii) where a prospective Supplier's Question is identified as commercially confidential in nature and where, the Toronto Zoo in its sole and absolute discretion deems the Question or response to be commercially confidential, the Toronto Zoo may provide a response only to that Supplier. The Toronto Zoo reserves the right to edit Questions for clarity and applicability to all Suppliers generally.
- .3 Pursuant to Section 1.7.1 (Addenda), responses to Questions prepared and circulated by the Toronto Zoo are not RFT documents and do not amend the RFT, unless such responses form part of an Addendum.

1.9 Submission of Bids

.1 General

- .1 Subject to Section 1.9.3 (Bid Bond) with respect to the submission of the Bid Bond, Bids must be in person Toronto Zoo prior to the Submission Deadline. Bids will be rejected as non-compliant if submitted by any other mechanism including, but not limited to, post, courier, fax, e-mail or orally, unless specifically requested Toronto Zoo
- .2 It is the Supplier's sole responsibility to ensure its Bid is received by the Submission Deadline in accordance with the requirements of this RFT. The receipt of Bids can be delayed due to a number of factors including "internet traffic", file transfer size and transmission speed. The Supplier should allow sufficient time to download, complete and upload, as applicable, the submission forms comprising its Bid and any attachments.
 - A Bid will only be considered to be submitted once it has been received by the Toronto Zoo. The time of such receipt is reflected by the time stamped by the Toronto Zoo.
- .3 Suppliers must submit their Bids in the format presented, prescribed and compatible with the requirements of the RFT and Toronto Zoo must include all attachments required by the Toronto Zoo. Failure to fully complete the forms presented in this RFT or to include and submit the required attachments or separate documentation, as applicable, may result in the bid being rejected as non-compliant.
- .4 The forms, documents and other items outlined in this Section 1.9 (Submission of Bids) must be completed in their entirety and submitted in the format presented and prescribed by the Toronto Zoo in accordance with the requirements of the RFT. Failure to so submit any such items may result in the Bid being rejected as non-compliant.
- .5 All Suppliers should exercise extreme care when completing their Bid submissions, as failure to complete the Bid fully or to comply with the requirements of this RFT may cause the Bid to be rejected as non-compliant.

Request for Tender
TZC T 38-2021-10 Retaining Wall Replacement
Part 1 – Instruction to Bidders – Section 1 – RFT SPECIFIC PROCESS AND SUBMISSION INSTRUCTIONS

.2 Bid Submission Form

- .1 Suppliers shall complete and submit all information and respond to all items in the Bid submission form set out in Form A of Part 4 (Bid Submission Form) (“**Bid Submission Form**”).
- .2 The Bid Submission Form contains confirmatory statements and declarations in respect of the Toronto Zoo's Policies.

.3 Bid Bond

- .1 In addition to the requirements set out in this RFT in respect of the submission of Toronto Zoo, each Supplier shall submit, a bid bond to secure the execution of the Contract by the Supplier (“**Bid Bond**”).

- .2 The Bid Bond shall be made out to the Toronto Zoo

- .1 an original paper Bid Bond shall be enclosed with your submission delivered to Purchasing & Supply before the Submission Deadline at the following address:

Attention: Supervisor, Purchasing & Supply
Toronto Zoo
361A Old Finch Ave
Toronto, ON
M1B 5K7

Re: Bid Bond for Request for Tender No. TZC T 38-2021-10

Submitting a photocopy of the original paper Bid Bond is not acceptable. For clarity, the Toronto Zoo will not accept any original paper Bid Bonds that are delivered after the Submission Deadline and any original paper Bid Bond received after the Submission Deadline shall result in the Bid being rejected as non-compliant.

[The determination of whether the original paper Bid Bond is delivered by or before the Submission Deadline shall be based on the time and date stamp, the Supplier must ensure it receives from the Toronto Zoo at foregoing address]

- .3 The Bid Bond shall be in the amount and in the form provided in Appendix IV of Part 4 (Bid Bond) or in another substantially similar format approved by the Toronto Zoo prior to Bid submission; and
- .4 The Bid Bond shall be signed and sealed by the Supplier and by a licensed surety company, authorized to carry on business in the Province of Ontario, and having a place of business in Ontario.

Request for Tender

TZC T 38-2021-10 Retaining Wall Replacement

Part 1 – Instruction to Bidders – Section 1 – RFT SPECIFIC PROCESS AND SUBMISSION INSTRUCTIONS

- .5 Failure of a Supplier to submit a Bid Bond, in compliance with the requirements of Sections 1.9.3.1 and 1.9.3.2 (Bid Bonds) shall result in the Bid being rejected as non-compliant.

.4 Experience and Qualifications Form

- .1 Each Supplier shall complete, and submit the Experience and Qualifications Form provided in Appendix I of Part 4 (Experience and Qualifications Form). In submitting such form the Supplier gives the Toronto Zoo consent to contact the references therein to confirm the information therein. Failure to provide the required information listed on the Experience and Qualifications Form shall render the Bid non-compliant. If, in the Toronto Zoo's sole and absolute discretion, the references do not confirm the Supplier's experience and qualifications as required by the RFT, the Bid will be declared non-compliant and will not be considered for acceptance.
- .2 The Toronto Zoo reserves the right to verify whether Suppliers are relying upon past experience of an Affiliated Person including the nature of the corporate relationship and its relevance to the Project. If, in the Toronto Zoo's sole and absolute discretion, it is determined that a Supplier is relying on an Affiliated Person's past experience and a transfer of the Affiliated Person's experience cannot be demonstrated as relevant to the Project then the Bid will be declared non-compliant and not be considered for acceptance.
- .3 The Toronto Zoo reserves the right to verify past performance of the Supplier or its Affiliated Persons with the Toronto Zoo's performance records on relevant Toronto Zoo projects (including the Toronto Zoo's agencies, boards, commissions and corporations).
- .4 The Toronto Zoo reserves the right to verify a mandatory certification of qualifications submitted by a Supplier for itself or its Affiliated Persons with any relevant third party certifying organization.

.5 List of Subcontractors Form

- .1 The Supplier shall complete and submit the form provided in Appendix II of Part 4 (List of Subcontractors Form) indicating the subcontractors it intends to employ to carry out each portion of the Work ("**Subcontractors**") indicated therein.
- .2 Suppliers must not include companies under suspension by the Toronto Zoo on their list of Subcontractors.

.6 Pricing Form

- .1 Each Supplier shall complete and submit the Pricing Form set out in Part 5 (PRICING FORM) according to the instructions contained in such form.

Request for Tender

TZC T 38-2021-10 Retaining Wall Replacement

Part 1 – Instruction to Bidders – Section 1 – RFT SPECIFIC PROCESS AND SUBMISSION INSTRUCTIONS

- .2 In completing the Pricing Form, Suppliers must take into account compliance with all of the requirements of the RFT, including Part 3 (DRAWINGS AND SPECIFICATIONS) and the terms of the Contract. The Toronto Zoo will assume, in evaluating all Bids, that compliance with such requirements has been accounted for in the completed Pricing Form.

1.10 Amendment of Bids

- .1 Prior to the Submission Deadline, a Supplier may amend its Bid at any time after submission of the Bid Toronto Zoo and a Supplier may amend its Bid one or more times if it so wishes prior to the Submission Deadline.
- .2 If a Supplier amends its Bid, the Supplier must resubmit the Bid prior to the Submission Deadline Toronto Zoo the most recently submitted version of the Bid as dated and stamped recorded Toronto Zoo, shall be irrevocable and binding in accordance with the provisions of the RFT, and may be accepted by the Toronto Zoo in its sole and absolute discretion unless such Bid has been properly withdrawn in accordance with Section 1.11 (Withdrawal of Bids).

1.11 Withdrawal of Bids

- .1 A Bid may be withdrawn at any time prior to the Submission Deadline by delivering written notice of withdrawal to the Procurement Contact by means of email or in person Toronto Zoo before the Submission Deadline.
- .2 For clarity, a Bid may only be withdrawn by delivering such notice to the Procurement Contact prior to the Submission Deadline and cannot be withdrawn by any other means. If a Supplier fails to properly withdraw a Bid, the Bid shall be considered to be the Supplier's submitted Bid, shall be irrevocable and binding in accordance with the provisions of the RFT, and may be accepted by the Toronto Zoo in its sole and absolute discretion, notwithstanding such failure.
- .3 Any Bids that are properly withdrawn will not be examined or evaluated for the purpose of the RFT but shall be retained for the Toronto Zoo's record retention purposes.

1.12 Bid Validity Period

- .1 Upon the Submission Deadline, each submitted Bid shall be irrevocable and binding on Suppliers for the period of time following the Submission Deadline as set out in the RFT timetable in Section 1.5 (RFT Timetable) ("**Bid Validity Period**").
- .2 In exceptional circumstances, prior to the expiration of the Bid Validity Period, the Toronto Zoo may request Suppliers to extend the validity of their Bids and any accompanying Bid Bonds. The request and responses shall be made in writing by the Procurement Contact Toronto Zoo. A Supplier may refuse the Toronto Zoo's request without rendering its Bid non-compliant. A Supplier granting the request shall not be required or permitted to modify its Bid.

SECTION 2 - EVALUATION, ACCEPTANCE AND EXECUTION

2.1 Evaluation

.1 Evaluation Process

- .1 The Toronto Zoo will conduct the evaluation of Bids in the following two stages.

Stage 1: The Bids will be reviewed to determine whether they comply with all of the mandatory requirements of the RFT, including the requirements of Section 1.9 (Submission of Bids). Bids that are substantially incomplete or do not substantially comply with the requirements of this RFT will be excluded from consideration in Stage 2.

Stage 2: The compliant Bids will be ranked on the basis of the submitted pricing of each in accordance with the price evaluation method set out in the Pricing Form.

- .2 Subject to its reserved rights set out in this Part, the Toronto Zoo may at any time and from time to time, in its sole and absolute discretion, revisit, revise, confirm or adjust the evaluations of a Bid at any time during the RFT process.

.2 Tied Bids

In the event that the Toronto Zoo receives two (2) or more Bids identical in price, the Toronto Zoo reserves the right to select one of such Bids as set out the Toronto Zoo's Policies. The Tied Bid procedure allows Toronto Zoo the tie to be broken by way of coin toss or lottery.

.3 Materially Unbalanced or Abnormally Low Bids

- .1 A Bid is materially unbalanced if:
- it is based on prices which are significantly less than cost for some items and prices which are significantly overstated in relation to cost for other items; and
 - the Toronto Zoo has determined that the Bid may not result in the lowest overall cost to the Toronto Zoo even though it may be the lowest submitted Bid; or
 - it is so unbalanced as to be tantamount to allowing an advance payment.
- .2 A Bid is abnormally low if the pricing, in combination with other constituent elements of the Bid, appears unreasonably low to the extent that the pricing raises material concerns with the Toronto Zoo as to the capability of the Supplier to perform the Contract on the basis of the offered pricing.

Request for Tender
TZC T 38-2021-10 Retaining Wall Replacement
Part 1 – Instruction to Bidders – Section 2 – EVALUATION, ACCEPTANCE AND EXECUTION

- .3 If a materially unbalanced Bid or an abnormally low Bid is identified, the Toronto Zoo may seek clarification from the Supplier, including a detailed price analysis of its pricing in relation to the subject matter of the Contract, the scope of Work, the estimated quantities, the schedule for the performance of the Work, the allocation of risks and responsibilities and any other requirements of RFT.
- .4 If after evaluation of the price analysis, the Toronto Zoo determines that the Supplier has failed to demonstrate its capability to perform the Contract on the basis of the offered pricing, or that the offered pricing in constitutes a material risk to the Toronto Zoo, the Toronto Zoo may reject the Bid.

2.2 Rights of the Toronto Zoo

In addition to, but without limiting any other rights or options of the Toronto Zoo under this RFT, the Toronto Zoo may, in its sole and absolute discretion carry out the RFT process as it determines to be in the best interests of the Toronto Zoo and to be the most beneficial to Toronto Zoo. The Toronto Zoo may, in its sole and absolute discretion, exercise any or all of the following rights and options with respect to this RFT, at any time.

- .1 The Toronto Zoo may waive minor irregularities in any Bid.
- .2 The Toronto Zoo shall not be obliged to accept or reject any Bid (in whole or in part), including if:
 - the Bid contents appear to be incorrect, inaccurate or inappropriate;
 - the Supplier has engaged in conduct prohibited by the RFT; or
 - the Supplier or any member of a Supplier's Joint Venture is or becomes bankrupt, insolvent, makes an assignment for the benefit of its creditors generally or has a receiver appointed over all or a substantial part of its assets.
- .3 The Toronto Zoo may suspend, modify and/or cancel this RFT (with or without the substitution of another RFT) or the Project.
- .4 The lowest quoted price may not necessarily be accepted by the Toronto Zoo.
- .5 The Toronto Zoo may verify the validity of a Bid including the Supplier's statements, claims, qualifications or capabilities, by whatever means the Toronto Zoo deems appropriate including obtaining references other than those offered by the Supplier, and conduct investigations as to the qualifications of each Supplier.
- .6 The Toronto Zoo may, at any time during the RFT process, require (within such time period as set by the Toronto Zoo) one, some or all of the Suppliers to:
 - submit supplementary information or documentation clarifying any matters contained in their Bid;

Request for Tender

TZC T 38-2021-10 Retaining Wall Replacement

Part 1 – Instruction to Bidders – Section 2 – EVALUATION, ACCEPTANCE AND EXECUTION

- meet with the Toronto Zoo to clarify aspects of their Bid;
- acknowledge and agree to the Toronto Zoo's interpretation of any aspect of a Bid,

provided, however, that the Toronto Zoo is not obliged to seek clarification of any aspect of a Bid and may request clarification from some but not all Suppliers. Such clarification may be in respect of clarification with respect to whether a Bid meets the mandatory requirements of the RFT or whether the Supplier meets the necessary experience and performance qualifications set out in the RFT, if any. Any supplementary information and documents submitted by a Supplier which have been accepted by the Toronto Zoo and the interpretations prepared by the Toronto Zoo which have been acknowledged and agreed to by a Supplier shall be considered to form part of the Bid.

- .7 The Toronto Zoo reserves the right to assess the ability of the Supplier to perform the Contract and may reject any Bid where, in the Toronto Zoo's sole determination, the personnel and/or resources of the Supplier are insufficient.
- .8 Bids that are improperly prepared, not in compliance with all of the requirements or instructions of the RFT, incomplete, improperly signed, conditional, qualified, illegible, obscure or contain reservations, additions not called for, arithmetical errors, omissions, erasures, alterations, or irregularities of any kind may, be considered informal or irregular and may be rejected or be retained by the Toronto Zoo for consideration and acceptance.
- .9 The Toronto Zoo may choose to meet with some or all of the Suppliers in connection with their Bids or the matters provided for in the RFT. The Toronto Zoo may visit the existing place or places of business of some or all Suppliers for purposes of clarification or verification.
- .10 The Toronto Zoo may award one or more contracts for portions or all of the Work to as many Suppliers and/or Other Persons as it deems appropriate, including awarding a contract for Work less than the scope or quantity contemplated in the Successful Supplier's Bid or the RFT.
- .11 The Toronto Zoo may issue a solicitation to one, some or all of the Suppliers and/or any Other Person.
- .12 After the Submission Deadline, the Toronto Zoo may increase or decrease the quantity of any unit of Work in accordance with the Contract.
- .13 The Toronto Zoo may exercise any other right or option provided for in, or in connection with, this RFT, including the rights and options set out in the Toronto Zoo's Policies.
- .14 The Toronto Zoo may do nothing in relation to the Bids or this RFT.

Request for Tender
TZC T 38-2021-10 Retaining Wall Replacement
Part 1 – Instruction to Bidders – Section 2 – EVALUATION, ACCEPTANCE AND EXECUTION

2.3 Contract Execution

- .1 Once a Bid has been accepted by the Toronto Zoo, the Procurement Contact will notify the Successful Supplier that it has been awarded the Contract.
- .2 The Successful Supplier will be required to execute and deliver the Contract as well as the other documentation set out below in this Section 2.3.2 (Contract Execution) by taking the following steps within ten (10) Business Days after being notified by the Toronto Zoo that the Contract is ready for execution:
 - .1 execute and return the Contract, without any unilateral revisions to the Contract;
 - .2 obtain and deliver a performance bond and a labour and material payment bond for the due and proper performance of the Work, each in accordance with the requirements of the Contract and signed and sealed by the Supplier and its surety;
 - .3 arrange for the certificate of insurance in the form attached as a part of the Contract to be completed and signed (including stamp of insurance broker) and delivered to the Toronto Zoo;
 - .4 A letter from Workplace Safety and Insurance Board certifying that the Contractor is in good standing with the Board. A "letter of good standing" must be re-submitted throughout the Contract every 90 days.
- .3 Should the Successful Supplier fail to execute and deliver the Contract and deliver the accompanying documents in accordance with the requirements of Section 2.3.2 (Contract Execution), the Successful Supplier shall be deemed to have abandoned all rights and interests in the Contract and the RFT and the Toronto Zoo may, without prejudice to any other remedy or right which it may have, exercise all or any one or more of the following rights:
 - rescind its award of the Contract;
 - call on the Bid Bond;
 - accept the Bid of the next highest ranked Supplier and proceed to execute the Contract with such Supplier; or
 - suspend the Successful Supplier from participating in other Toronto Zoo procurement processes for such period of time as may be determined under the Supplier Performance Evaluation .

Request for Tender
TZC T 38-2021-10 Retaining Wall Replacement
Part 1 – Instruction to Bidders – Section 2 – EVALUATION, ACCEPTANCE AND EXECUTION

2.4 Notification to Other Suppliers

Once the Successful Supplier is notified that the Toronto Zoo has awarded the Contract, the other Suppliers will be notified by the Toronto Zoo in writing Toronto Zoo of the outcome of the RFT process.

2.5 Debriefing

Unsuccessful Suppliers may request a debriefing after receipt of a notification of the outcome of the selection process. All requests must be in writing to the Procurement Contact Toronto Zoo. The intent of the debriefing information session is to aid the Supplier in presenting a better bid in subsequent procurement opportunities. Any debriefing provided is at the sole and absolute discretion of the Toronto Zoo, and not for the purpose of providing an opportunity to challenge the RFT process.

SECTION 3 - GENERAL RFT TERMS AND CONDITIONS

3.1 General Process Terms and Conditions

- .1 Suppliers acknowledge that their Bids are governed by the terms and conditions set out in this RFT as well as the by-laws, policies and procedures established by the Toronto Zoo (including the Toronto Zoo's Policies and Procedures) and any additional terms and conditions related to the provision of the Toronto Zoo and Suppliers will become familiar, and comply with, all of the foregoing. Each Supplier shall comply with the Toronto Zoo's Policies and Procedures including the specific policies set out in Form A of Part 4 – Bid Submission Form (Toronto Zoo's Policies and Procedures) and elsewhere in this RFT. It is the responsibility of the Supplier to review all such policies.
- .2 Suppliers should structure their bids in accordance with the instructions in this RFT. Where information is requested in this RFT, any response made in a Bid should reference the applicable section numbers of this RFT.
- .3 The Toronto Zoo will have no obligation to consider information, documentation or other content not included in a Bid for the purpose of evaluating the Bid. For clarity, the Toronto Zoo will not consider any content referred to in but not included in the Bid, including information referenced by links to websites or other external documents.

3.2 Suppliers Shall Bear Their Own Costs

Each Supplier shall bear all costs, expenses and financial obligations associated with or incurred by the Supplier to: (i) prepare and present its Bid or to otherwise participate in the RFT process including, if applicable, costs incurred for samples, interviews or demonstrations; or (ii) to establish a legally binding contract with the Toronto Zoo.

3.3 Limitation of Liability

- .1 Notwithstanding anything in the RFT and any express or implied duties or obligations of the Toronto Zoo to the contrary, the Toronto Zoo and each of its agencies, boards, commissions, elected officials, officers, employees, servants, agents, volunteers, suppliers, advisers and contracted personnel will have no liability to any Person, including any Supplier and prospective Supplier for any damages, costs, liabilities, losses or expenses including direct, indirect, special or punitive damages, or for loss of profits, loss of opportunity or loss of reputation arising out of or otherwise relating to:
 - this RFT,
 - participation of any such Person in this RFT process;
 - the provision and availability or lack of availability or accuracy of the Toronto Zoo RFT issued by the Toronto Zoo; or
 - the Toronto Zoo's acts or omissions in connection with the conduct of this RFT process, including the acceptance, non-acceptance or delay in acceptance by the Toronto Zoo of any Bid.
- .2 This limitation applies to all possible claims, whether arising in contract, tort, equity, or otherwise, including any claim for a breach by the Toronto Zoo of a duty of fairness, if any, or relating to a failure of the Toronto Zoo to comply with the rules set out in this

Request for Tender

TZC T 38-2021-10 Retaining Wall Replacement

Part 1 – Instruction to Bidders – Section 3 – GENERAL RFT TERMS AND CONDITIONS

RFT. By submitting a Bid to the Toronto Zoo, each Supplier irrevocably and unconditionally waives any claims for damages, costs, liabilities, losses and expenses, and shall not seek any order for injunctive relief or specific performance, against the Toronto Zoo, its agencies, boards, commissions, elected officials, officers, employees, servants, agents, volunteers, advisers and contracted personnel.

- .3 Each Supplier agrees that, despite Section 3.3.1(Limitation of Liability) or any limitations of liability or releases in favour of Toronto Zoo, if the Toronto Zoo is found to be liable, in any way whatsoever, for any act or omission in respect of the RFT Toronto Zoo to any Supplier or any other Person participating in the RFT process, and the aggregate amount of damages recoverable against Toronto Zoo for any matter relating to or arising from any act or omission by the Toronto Zoo, whether based upon an action or claim in contract, warranty, equity, negligence, intended conduct or otherwise, including any action or claim arising from the acts or omissions, negligent or otherwise, of the Toronto Zoo shall be no greater than the Supplier's cost of preparing its Bid.
- .4 Notwithstanding the Toronto Zoo's limitation of liability, the Supplier may seek a debriefing or may pursue a dispute of the RFT process in accordance with the Toronto Zoo's Policies and Legislation.

3.4 Joint Venture Bids

A Supplier may be a private legal entity or any combination of such entities in the form of a joint venture (**Joint Venture**) under and existing agreement or with the intent to enter into such an agreement as supported by a letter of intent. In the case of a Joint Venture, all members shall be jointly and severally liable for the execution of the entire contract if selected by the Toronto Zoo. The Joint Venture shall nominate a representative who shall have the authority to conduct all business on behalf of all members of the Joint Venture during the procurement process and for the execution and performance of any resulting contract.

3.5 Participation in Multiple Bids

Submission or participation in more than one Bid by a Supplier will result in the disqualification of all proposals in which the Supplier is involved. This does not limit the inclusion of the same subcontractor from being named in more than one Bid as a subcontractor only.

3.6 Toronto Zoo Materials

- .1 The RFT and all correspondence, data, plans, materials, drawings, specifications, reports, estimates, summaries, photographs, models and all other information and documentation in any form provided or made available to any Supplier or prospective Supplier by, or on behalf of, the Toronto Zoo in connection with, or arising out of this RFT (collectively, the "**Toronto Zoo Materials**") and all intellectual property rights therein:
 - are and shall remain the sole and absolute property of the Toronto Zoo;
 - must be treated by Suppliers and prospective Suppliers as confidential and Suppliers must maintain such confidentiality;

Request for Tender

TZC T 38-2021-10 Retaining Wall Replacement

Part 1 – Instruction to Bidders – Section 3 – GENERAL RFT TERMS AND CONDITIONS

- must not be disclosed without prior written authorization from the Toronto Zoo;
 - must not be used for any purpose other than for replying to this RFT, and for fulfillment of the Contract or any related subsequent agreement; and
 - immediately upon the request of the Toronto Zoo, must be returned by the Supplier to the Toronto Zoo and all electronic copies must be destroyed.
- .2 Unless and to the extent provided otherwise in the Contract, the Toronto Zoo and its advisers make no representation or warranty as to the accuracy or completeness of the Toronto Zoo Materials. Any quantities shown or data contained in the Toronto Zoo Materials are estimates only and are for the sole purpose of indicating to Suppliers the general scale and scope of the Work. Use of or reliance by Suppliers on the Toronto Zoo Materials Toronto Zoo shall be at the Supplier's sole risk and without recourse against the Toronto Zoo.
- .3 It is the Suppliers' responsibility to make their own independent investigations, due diligence, projections and conclusions, and consult their own advisors, to obtain all the information necessary to:
- verify and confirm the accuracy and completeness of the Toronto Zoo Materials, unless and to the extent provided otherwise in the Contract;
 - Toronto Zoo satisfy themselves as to all existing conditions affecting the Project or the Contract; and
 - prepare their Bids in response to this RFT.

3.7 Ownership of Bid Materials

- .1 The documentation comprising any Bid, along with all correspondence, data, plans, materials, drawings, specifications, reports, estimates, summaries, photographs, models and all other information and documentation in any form provided or made available to the Toronto Zoo by, or on behalf of, any Supplier in connection with, or arising out of this RFT (collectively, the "**Bid Materials**") and all intellectual property rights therein, once received by the Toronto Zoo:
- shall become the sole and absolute property of the Toronto Zoo;
 - shall become subject to MFIPPA, and the Toronto Zoo may be required to disclose the Bid Materials members of the public, pursuant to MFIPPA.
- .2 Each Supplier:
- represents and warrants that the information contained in its Bid Materials does not infringe any intellectual property right of any third party;
 - hereby assigns and transfer to the Toronto Zoo, and shall cause all its personnel and other third parties to assign and transfer to the Toronto Zoo, all right, title and interest in the Bid Materials, including intellectual property rights therein:

Request for Tender

TZC T 38-2021-10 Retaining Wall Replacement

Part 1 – Instruction to Bidders – Section 3 – GENERAL RFT TERMS AND CONDITIONS

- shall cause all its personnel and other third parties to waive, for the benefit of the Toronto Zoo, their respective moral rights (and any similar rights to the extent that such rights exist) in and to the Bid Materials; and
 - shall indemnify, defend and hold harmless the Toronto Zoo, City of Toronto and Toronto Regional Conservation Authority and its agencies, boards, commissions, elected officials, officers, employees, servants, agents, volunteers, advisers and contracted personnel, if any, against all claims, actions, suits and proceedings brought against, or losses, costs, expenses, damages suffered, sustained, or incurred by them which may be directly or indirectly attributable to, or arising or alleged to arise out of the infringement or alleged infringement of any patent, copyright, trademark, or other intellectual property right of a third party in connection with the Bid Materials.
- .3 Suppliers are also advised that MFIPPA does provide protection for confidential and proprietary business information. For the purposes of the Toronto Zoo's compliance with MFIPPA, Suppliers are advised to identify in their Bid Materials material any scientific, technical, commercial, proprietary or similar confidential information, the disclosure of which could cause them injury.
- .4 Each Supplier's name and total bid price may be made public. Bid Materials will, as necessary, be made available:
- on a confidential basis, to advisers retained by the Toronto Zoo to advise or assist with the RFT process;
 - to members of Council in accordance with the Toronto Zoo's procedures; and
 - to members of the public pursuant to MFIPPA.
- .5 The Toronto Zoo will not return the Bid or any other Bid Materials.

3.8 Failure or Default of Supplier

- .1 Without prejudice to any other right or remedy available to the Toronto Zoo under this RFT or at law, if the Supplier, for any reason, fails or defaults in respect of an obligation of the Supplier under the terms of the RFT, the Toronto Zoo may:
- disqualify the Supplier from the RFT and/or from competing for any future solicitations issued by the Toronto Zoo; and
 - require the Supplier to pay the Toronto Zoo the difference between its Bid and any other Bid which the Toronto Zoo accepts, if the latter is for a greater amount and, in addition, to pay the Toronto Zoo any other cost which the Toronto Zoo may incur by reason of the Supplier's failure or default.
- .2 The Supplier shall be ineligible to submit a new bid for any solicitations that the Toronto Zoo is required to reissue as a result of the Supplier's failure or default under

Request for Tender
TZC T 38-2021-10 Retaining Wall Replacement
Part 1 – Instruction to Bidders – Section 3 – GENERAL RFT TERMS AND CONDITIONS

the Contract or where the Toronto Zoo deems that the Supplier has abandoned the Contract.

3.9 Trade Agreements

Suppliers should be aware that procurements falling within the scope of the Canadian Free Trade Agreement or other trade agreements applicable to the Toronto Zoo are subject to such agreements, but the rights and obligations of the parties will be governed by the specific terms of this RFT

3.10 Governing Law and Enforceability

- .1 The terms and conditions of the RFT process are to be governed by and construed in accordance with the Toronto Zoo's Policies, the laws of the province of Ontario and the federal laws of Canada applicable therein.
- .2 If any provision of the RFT or its application to any party or circumstance is unenforceable, the provision shall be ineffective only to the extent of the unenforceability without: (i) invalidating the remaining provisions of the RFT; (ii) changing the fundamental nature of the obligations assumed by the parties; and (iii) affecting its application to other parties or circumstances.

3.11 RFT Definitions and Interpretation

.1 Definitions

Throughout this RFT, unless inconsistent with the subject matter or context, the following definitions shall apply other than in respect of Part 2 (FORM OF CONSTRUCTION AGREEMENT).

- .1 **“Addenda”** or **“Addendum”** means a document containing additional information and/or changes to the RFT issued by the Toronto Zoo on its website.
- .2 **“Bid”** means an offer submitted by a Supplier in response to the RFT, which includes all of the documentation necessary to satisfy the submission requirements of the RFT and **“Bids”** shall have a corresponding meaning;
- .3 **“Bid Bond”** has the meaning set out in Section 1.9.3 (Bid Bonds).
- .4 **“Bid Materials”** has the meaning set out in Section 3.7.1 (Ownership of Bid Materials).
- .5 **“Bid Submission Form”** has the meaning set out in Section 1.9.2 (Bid Submission Form).
- .6 **“Bid Validity Period”** has the meaning set out in Section 1.12. (Bid Validity Period).
- .7 **“Business Day”** means a day other than:
 - .1 a Saturday, Sunday, statutory holiday, or statutory vacation day that is observed by the Toronto Zoo of Toronto; or

Request for Tender
TZC T 38-2021-10 Retaining Wall Replacement
Part 1 – Instruction to Bidders – Section 3 – GENERAL RFT TERMS AND CONDITIONS

- .2 a day identified by the Toronto Zoo as a designated or statutory holiday
- .8 “**Toronto Zoo**” means the Board of Management of the Toronto Zoo.
- .9 “**Materials**” has the meaning set out in Section 3.6 (Toronto Zoo Materials).
- .10 “**Contract**” means the contract in the form set out in Part 2 (FORM OF CONSTRUCTION AGREEMENT) to be executed by the Successful Supplier and the Toronto Zoo, which sets out the terms and conditions for the performance of the Work.
- .11 “**Joint Venture**” has the meaning set out in Section 3.4 (Joint Venture Bids).
- .12 “**MFIPPA**” means the *Municipal Freedom of Information and Protection of Privacy Act*, as amended, supplemented, re-enacted or replaced from time to time.
- .13 “**Person**” means any individual, partnership, limited partnership, firm, joint venture, syndicate, company or corporation with or without share capital, trust, trustee, executor, administrator or other legal personal representative, governmental authority or entity however designated or constituted
- .14 “**Procurement Contact**” has the meaning set out in Section 1.2 (Procurement Contact).
- .15 “**Project**” has the meaning set out in Section 1.1 (Introduction).
- .16 “**RFT**” means this RFT package in its entirety, including all documents listed in Section 1.3 (RFT Documents) and Addenda that may be issued by the Toronto Zoo.
- .17 “**Subcontractor**” means a Person undertaking the execution of a part of the Work by virtue of an agreement with the Contractor.
- .18 “**Submission Deadline**” means the specified deadline for Bids to be submitted to the Toronto Zoo as indicated in the RFT timetable in Section 1.5 (RFT Timetable).
- .19 “**Successful Supplier**” means the Supplier that has been selected to enter into the Contract for the performance of the Work.
- .20 “**Supplier**” means a Person, including, where applicable, a Joint Bid Team, that submits a Bid in response to this RFT and “**Suppliers**” shall have a corresponding meaning.
- .21 “**Work**” means all work, services and deliverables to be provided by a Contractor in respect of the Project as described in this RFT.

.2 Interpretation of the RFT

- .1 Except where otherwise requested, all documents relating to the Bid and all communications between Suppliers and the Toronto Zoo will be in the English language.

Request for Tender

TZC T 38-2021-10 Retaining Wall Replacement

Part 1 – Instruction to Bidders – Section 3 – GENERAL RFT TERMS AND CONDITIONS

- .2 Except where otherwise disclosed, all references to times in this RFT will mean local time in Toronto, Ontario, Canada.
- .3 The phrase “includes” “, include” or “including” means “includes, without limitation” or “including” or “include, without limitation”.
- .4 In the RFT, unless the context otherwise requires, words importing the singular include the plural and vice versa and words importing gender include all genders.
- .5 Unless otherwise stated herein, all amounts in the RFT are in Canadian dollars, including any amounts provided in the Pricing Form.
- .6 In addition to the words defined in Section 13.13.1 (Definitions), the other words used in this RFT shall be interpreted consistent with the definitions contained in the Toronto Zoo's Policies..

**Request for Tender
TZC T 38-2021-10 Retaining Wall Replacement
Part 1 – Instruction to Bidders – SUBMISSION LABEL**

SUBMISSION LABEL (N/A)

This address label should be affixed to the front of your sealed tender, quotation and proposal envelope/package submission. Toronto Zoo will not be held responsible for envelopes and packages that are not properly labelled or submitted to an address other than the one listed on this label.

Vendor Name _____

**TZC T 38-2021-10 – Retaining Wall Replacement
Closing: Wednesday, 2021-11-17, 12:00 (noon) local time**

**TO BE RETURNED TO
TORONTO ZOO
C/O SUPERVISOR, PURCHASING & SUPPLY
ADMINISTRATIVE SUPPORT CENTRE
361A OLD FINCH AVE.
TORONTO, ONTARIO
M1B 5K7**



**CONSTRUCTION AGREEMENT
CONTRACT TZC T 38-2021-10**

for

**Facilities & Infrastructure, Project Management
Branch**

Retaining Wall Replacement

NOTICE RE: CONSTRUCTION ACT

* Parts I.1 (Prompt Payment) and II.1 (Adjudication) of the Construction Act apply with respect to this Agreement and all subcontracts thereunder.

* All claims for lien (Form 12) must be completed and submitted through the City of Toronto's website at www.toronto.ca/liens, pursuant to section 34(3.1) of the Construction Act and section 11.1 of O. Reg 304/18.

TABLE OF CONTENTS

	Page
AGREEMENT	1
1. THE WORK.....	1
2. CONTRACT PRICE	1
3. DOCUMENTS COMPRISING THE AGREEMENT	2
SCHEDULE A – INFORMATION SHEET	4
SCHEDULE B – PRICING FORM	9
SCHEDULE C – DEFINITIONS	10
SCHEDULE D – GENERAL CONDITIONS	23
1. GENERAL PROVISIONS	23
GC 1.1 Interpretation.....	23
GC 1.2 Entire Agreement And Amendments	25
GC 1.3 Law of the Agreement and Interpretation	26
GC 1.4 Rights and Remedies.....	27
GC 1.5 Assignment and Succession	27
GC 1.6 Receipt of and Addresses for Notices and Documentation.....	28
GC 1.7 Conflicts of Interest	29
GC 1.8 Miscellaneous	29
2. ADMINISTRATION OF THE AGREEMENT	29
GC 2.1 Authority of the Contract Administrator and the Owner Representative	29
GC 2.2 Role of the Contract Administrator	30
GC 2.3 Review and Inspection of the Work	32
GC 2.4 Emergency Situations	34
GC 2.5 Deficiencies	35
GC 2.6 Contractor Records.....	36
3. EXECUTION OF THE WORK	36
GC 3.1 Control and Commencement of the Work	36
GC 3.2 Supplemental Instructions	37
GC 3.3 Construction by Owner or Other Contractors	38
GC 3.4 Temporary Work	39
GC 3.5 Construction Schedule	39
GC 3.6 Document Review and Examination of Site.....	40
GC 3.7 Supervision	41
GC 3.8 Subcontractors and Suppliers	43
GC 3.9 Labour and Products.....	45
GC 3.10 Documents at the Site.....	47
GC 3.11 Shop Drawings	47

Construction Agreement
Table of Contents

	Page
GC 3.12 Use of the Work	49
GC 3.13 Standard of Care, Quality Assurance and Quality Control.....	49
GC 3.14 Use and Occupancy of the Work Prior to Substantial Performance of the Work.....	49
GC 3.15 Access to Properties Adjoining the Work and Interruption of Operations.....	50
4. PROTECTION OF PERSONS, WORK AND PROPERTY.....	51
GC 4.1 Protection of Work and Property	51
GC 4.2 Health and Safety	53
GC 4.3 Hazardous Materials	55
GC 4.4 Mould.....	57
GC 4.5 Artifacts and Fossils.....	58
5. CONTRACT PRICE AND PAYMENT	58
GC 5.1 Contract Price	58
GC 5.2 Owner's Obligation to Pay.....	59
GC 5.3 Proper Invoices	59
GC 5.4 Progress Payment	64
GC 5.5 Substantial Performance of the Work.....	65
GC 5.6 Payment of Lien Holdback Upon Substantial Performance of the Work	66
GC 5.7 Payments Upon Total Performance of the Work	67
GC 5.8 Final Acceptance Certificate	69
GC 5.9 Contractor Discharge of Liabilities.....	69
GC 5.10 Owner's Set-off	69
6. ALLOWANCES	70
GC 6.1 Allowances.....	70
7. CHANGES IN THE WORK.....	71
GC 7.1 Owner's Right to Make Changes.....	71
GC 7.2 Change Order	72
GC 7.3 Change Directive	73
GC 7.4 Concealed or Unknown Conditions	73
GC 7.5 Delays.....	74
GC 7.6 Delay Liquidated Damages	77
GC 7.7 Claims Procedure	78
GC 7.8 Service Standards for Contractor in Responding to Third Party Claimants.....	80
8. INSURANCE, CONTRACT SECURITY, BONDS AND CONTRACTUAL HOLDBACK.....	82
GC 8.1 Insurance.....	82
GC 8.2 Contract Security	86
GC 8.3 Surety Bonds	86
GC 8.4 Contractual Holdback.....	87

Construction Agreement
Table of Contents

	Page
9. INDEMNIFICATION, WAIVER OF CLAIMS AND WARRANTY	88
GC 9.1 Indemnification.....	88
GC 9.2 Waiver of Claims.....	90
GC 9.3 Warranty	90
10. GOVERNING REGULATIONS.....	92
GC 10.1 Laws, Notices, Permits, and Fees.....	92
GC 10.2 Taxes and Duties.....	93
GC 10.3 Patent Fees	95
GC 10.4 Workers' Compensation.....	95
11. DEFAULT, TERMINATION AND SUSPENSION.....	95
GC 11.1 Owner's Right to Perform the Work, Terminate the Contractor's Right to Continue with the Work, Terminate the Agreement or Suspend the Work.....	3
GC 11.2 Contractor's Right to Terminate the agreement.....	100
GC 11.3 Other Termination Obligations	101
12. DISPUTE RESOLUTION.....	101
GC 12.1 Dispute Resolution.....	101
GC 12.2 Adjudication	102
GC 12.3 Negotiations.....	105
GC 12.4 Mediation	105
GC 12.5 Arbitration	106
GC 12.6 Rights of Both Parties	106
13. OTHER PROVISIONS	106
GC 13.1 Ownership of Existing Materials and Equipment	106
GC 13.2 Construction Liens	107
GC 13.3 Ownership of Contractor Documents	107
GC 13.4 Owner Supplied Material.....	108
GC 13.5 Confidential Information and Personal Information.....	109

**Construction Agreement
Table of Contents**

	Page
SCHEDULE E – VALUING CHANGES IN THE WORK	113
1. CHANGES IN THE WORK BASED ON UNIT PRICES SET OUT IN THE AGREEMENT.....	113
2. CHANGES IN THE WORK ON A NEGOTIATED FIXED PRICE OR NEGOTIATED UNIT PRICE BASIS.....	113
3. CHANGES IN THE WORK ON A TIME AND MATERIAL BASIS – VERTICAL APPROACH.....	115
SCHEDULE F – OWNER POLICIES, PROCEDURES, BY-LAWS AND OTHER REQUIREMENTS	120
SCHEDULE G – FORMS	121
Form 1 SAMPLE PROPER INVOICE.....	122
Form 2 CERTIFICATE OF INSURANCE.....	123
Form 3 TAX STATUTORY DECLARATION.....	125
Form 4 NOTICE OF ADJUDICATION.....	126
SCHEDULE H – DRAWINGS AND SPECIFICATIONS	128

AGREEMENT BETWEEN OWNER AND CONTRACTOR

This Agreement entered into on the Effective Date

between

The Board of Management of the Toronto Zoo

(“Owner”)

and

● **[Note to Finalization before Execution: Insert Legal Name of Contractor]**

(“Contractor”)

WHEREAS Parts I.1 (Prompt Payment) and II.1 (Adjudication) of the Construction Act apply with respect to this Agreement and all subcontracts thereunder as the Owner commenced a procurement process for the improvement that is subject of the Agreement (“**Procurement Process**”) on or after October 1, 2019;

AND WHEREAS ● **[Note to Finalization before Execution: Complete recitals];**

NOW THEREFORE in consideration of the mutual covenants herein contained, the Owner and the Contractor agree as follows:

1. THE WORK

The Contractor shall:

- 1.1 perform the Work required by the Agreement for the Project located at the Site; and
- 1.2 do and fulfill everything indicated by the Agreement; and
- 1.3 commence the Work on the Commencement Date and, subject to adjustment in Contract Time as provided for in the Agreement, attain Substantial Performance of the Work, by the Scheduled Date for Substantial Performance of the Work, and otherwise perform the Work in accordance with the Construction Schedule.

2. CONTRACT PRICE

- 2.1 The price for the Work (including any changes in the Work), which excludes Value Added Taxes, is the sum of, if applicable:
 - .1 in respect of the Fixed Price Work, the Fixed Price; plus
 - .2 in respect of the Unit Price Work, the Total Price of Unit Price Work; plus

Construction Agreement

- .3 in respect of T&M Changes in the Work recorded in a Change Order, the T&M Price, (the “**Contract Price**”).
- 2.2 Value Added Taxes in the percentage amount of thirteen percent (13%) are payable by the Owner to the Contractor.
- 2.3 The Contract Price shall only be subject to adjustment as provided in the Agreement.
- 2.4 All amounts in the Agreement are expressed and payable in Canadian currency, unless expressly noted otherwise.

3. DOCUMENTS COMPRISING THE AGREEMENT

- 3.1 The following documents whether attached hereto or referred to herein form an integral part of the Agreement:
 - Schedule A – Information Sheet
 - Schedule B – Pricing Form
 - Schedule C – Definitions
 - Schedule D – General Conditions
 - Schedule E – Valuing Changes in the Work
 - Schedule F – Owner Policies, Procedures, By-Laws and Other Requirements
 - Schedule G – Forms
 - Form 1 – Proper Invoice
 - Form 2 – Certificate of Insurance
 - Form 3 – Tax Statutory Declaration
 - Form 4 – Notice of Adjudication
 - Schedule H – Drawings and Specifications
 - Construction Schedule
 - Supplemental Instructions
 - any other document identified elsewhere in the Agreement as a document forming part of the Agreement.

Construction Agreement

The parties hereto have executed this Agreement by the hands of their duly authorized representatives.

SIGNED AND DELIVERED

in the presence of:

The Board of Management of the Toronto Zoo

● **[Note to Finalization before Execution:
Authority stamp to be completed by the
Owner]**

By:

Name: ●
Title: ●
I have authority to bind the corporation

By:

Name: ●
Title: ●
I have authority to bind the corporation

● **[Note to Finalization before Execution:
Insert Legal Name of Contractor]**

By:

Name: ●
Title: ●
I have authority to bind the corporation

By:

Name: ●
Title: ●
I have authority to bind the corporation

[Note to Finalization before RFT/Execution: If the Contractor is an individual, use the following signature block. Delete signature block not used. Consult Legal Services if needed.]

SIGNED, SEALED & DELIVERED

In the presence of:

Witness

Name

**SCHEDULE A
INFORMATION SHEET**

[Note to Finalization before Execution: Revise A.3, A.4, A.5 and A.6 with information provided after award.]

The following table provides information cross-referenced in the provisions of the Agreement. All reference to GCs are located in Schedule D – General Conditions.

Row	Input Information	Reference	Description
A. Names and Information			
A.1	Project	Sch. C, Definition 79 & GC 3.8.2.3(1)	Supply all labour, tools, materials, and equipment required to replace retaining walls at the Toronto Zoo.
A.2	Site	Definition 90	Work under this contract will take place at: 361A Old Finch Ave, Toronto, ON M1B 5K7
A.3	Notice information	GC 1.6.1.2, GC 1.6.1.3 & GC 1.6.1.4	To be provided after award.
A.4	Identity of Contract Administrator	Sch. C, Definition 24	To be provided after award.
A.5	Identity of Owner Representative	Sch. C, Definition 70	To be provided after award.
A.6	Approved Subcontractors	GC 3.8.3, GC 3.8.3.1 & GC 3.8.3.2	To be entered after award.
B. Pricing, Markups and Liquidated Damages			
B.1	Contractor's Markup for negotiated fixed price and negotiated unit price changes in the Work performed by Contractor	Sch. E, s. 2.2.3.1	Not Applicable Note: All markups for Labour and Equipment shall be included in the Unit Bid Prices. No additional markups will be paid.
B.2	Total Cumulative Markup allowed for Contractor,	Sch. E, s. 2.2.3.2	Zero percent (0%)

**Construction Agreement
Schedule A – Information Sheet**

Row	Input Information	Reference	Description
	Subcontractors, Suppliers and Sub-subcontractors on negotiated fixed price and negotiated unit price changes in the Work performed by Subcontractors, Suppliers or Sub-subcontractors (and not performed by the Contractor)		
B.3	T&M Percentage Markup for changes in the Work performed by Contractor	Sch. E, s. 3.3.1	Ten percent (10%)
B.4	Total Cumulative T&M Percentage Markup allowed for Contractor, Subcontractors, Suppliers and Sub-subcontractors on changes in the Work performed by Subcontractors, Suppliers or Sub-subcontractors (and not performed by the Contractor)	Sch. E, s. 3.3.2	Fifteen percent (15%)
B.5	Markup for Cash Allowance overages	GC 6.1.4	Ten percent (10%)
B.6	Amounts of Delay Liquidated Damages	GC 7.6.1	None.
B.7	Changes in the Work on a Time & Material Basis	Sch. E, s. 3	Vertical approach.
B.8	Schedule A Schedule of Prices	Sch. B	Not applicable.

**Construction Agreement
Schedule A – Information Sheet**

Row	Input Information	Reference	Description
	for Changes in the Work		
B.9	Invoice Period	Sch. C, Definition 54	No change to default Invoice Period
B.10	Giving of a Proper Invoice	GC 5.3.1	Proper invoices shall be given to the Owner by referencing GC 1.6.1.1
C. Dates, Time Periods and Deadlines			
C.1	Effective Date	Sch. C, Definition 40	To be finalized after award.
C.2	Commencement Date	Sch. C, Definition 17 & GC 3.1.6	2021-11-22
C.3	Key Work Milestones	Sch. C, Definition 55	Not applicable
C.4	Scheduled Date for Substantial Performance of the Work	Sch. C, Definition 86	2022-04-29
C.5	Scheduled Date for Total Performance of the Work	Sch. C, Definition 87	2021-05-13
C.6	Warranty Period	Sch. C, Definition 113	No change to default Warranty Period.
C.7	Working Days	Sch. C, Definition 115	No change to default Working Days.
C.8	Number of Days for Contract Administrator to Issue a Certificate for Payment	GC 5.4.1.2	28 Calendar Days after receipt of a Proper Invoice.

**Construction Agreement
Schedule A – Information Sheet**

Row	Input Information	Reference	Description
C.9	Deadline to acknowledge a Contemplated Change Order	GC 7.2.1	No change to default of 10 Working Days.
C.10	Deadline to respond to a Change Directive	GC 7.3.5	5 Working Days.
C.11	Suspension Period for Stop Work Orders	GC 11.2.1	No change to default of 60 Working Days.
D. Insurance, Contract Security, Bonds and Contractual Holdback			
D.1	Insurance Coverages	GC 8.1.1.1, GC 8.1.1.2, GC 8.1.1.3 & GC 8.1.3	Automobile Liability Insurance shall have limits of not less than two million dollars (\$2,000,000). Pollution Liability Insurance coverage is not required.
D.2	Additional Contract Security	GC 8.2.1	Not Applicable
D.3	Amount of the Contractual Holdback	GC 8.4.1	Not Applicable
D.4	Percentage by which Contractual Holdback is Reduced after Total Performance of the Work	GC 8.4.3	Not Applicable
D.5	Surety Bonds	GC 8.3.1	No change to requirements in GC 8.3.1
E. Miscellaneous			
E.1.	Alternate order of priority of the Agreement Documents	GC 1.1.7.1	No change to default order of priority
E.2.	Allowable Portion of the Work for Subcontracting	GC 3.8.1	Not Applicable
E.3.	Accuracy of Utilities and Structures	GC 4.1.4.1	Contractor to rely on accuracy of positions of Utilities and Structures provided in the Agreement, subject to the following tolerances: on any

**Construction Agreement
Schedule A – Information Sheet**

Row	Input Information	Reference	Description
			drawing, 2 meters horizontally, and 1 metre vertically
E.4.	Fair Wage Schedule	Sch. F, if applicable	Fair Wage Policy is applicable. Use the City of Toronto's Fair Wage Policy available at https://www.toronto.ca/business-economy/doing-business-with-the-city/understanding-the-procurement-process/fair-wage-office-policy/fair-wage-policy/
E.5.	Workforce Development Plan	Sch. F, if included	There is <u>no requirement</u> for a Workforce Development Plan under this Agreement.

SCHEDULE B

PRICING FORM

Pricing Form is provided within the Tender Posting (Part 5) on the Toronto Zoo's Website

[Note to Finalization before Execution: Attach Pricing Form]

SCHEDULE C

DEFINITIONS

The following Definitions shall apply to the Agreement.

- 1. Adjudicable Dispute**
A dispute respecting an Adjudicable Matter and that complies with GC 12.1.2.
- 2. Adjudicable Matter**
Any matter:
 1. referred to in s. 13.5(1) of the Construction Act, other than in paragraph 7;
 2. that is prescribed under the Construction Act as referable to adjudication; or
 3. agreed to by the parties pursuant to GC 12.2.1.2.
- 3. Adjudication**
Adjudication means a construction dispute interim adjudication under Part B.1 of the Construction Act.
- 4. Adjudicator**
Adjudicator means an individual who is qualified by the Authority as an adjudicator.
- 5. Agreement**
Agreement means the agreement between Owner and Contractor and the Schedules attached thereto, as the same may be amended, supplemented, restated or replaced from time to time in writing upon the mutual agreement of the parties or as may be otherwise provided for in the Agreement.
- 6. Allowance**
Allowance means a Cash Allowance or Provisional Allowance, as applicable.
- 7. As-Built Drawings**
As-Built Drawings has the meaning set out in GC 3.10.2.
- 8. Authority**
Authority means the Authorized Nominating Authority designated under the Construction Act.
- 9. Calendar Day**
Calendar Day means a calendar day.
- 10. Cash Allowance**
Cash Allowance means the allowances, if any, identified in the Pricing Form for known items included in the Work where the actual cost was unknown at the time of tender. The Contractor's overhead and profit is excluded from Cash Allowance and is carried in other pricing as set out in GC 6.1.2.

Construction Agreement Schedule C – Definitions

- 11. Certificate of Recognition (COR™)**
Certificate of Recognition (COR™) means the nationally recognized occupational health and safety certification granted to qualifying firms by the Infrastructure Health and Safety Association (IHSA) of Ontario or its successor.
- 12. Change Directive**
A Change Directive means a written instruction, which shall be deemed incorporated into and forming part of the Agreement, prepared by the Contract Administrator and signed by the Owner directing the Contractor to proceed with a change in the Work prior to or in the absence of the Owner and the Contractor agreeing upon adjustments in the Contract Price and the Contract Time.
- 13. Change Order**
A Change Order means a written amendment to the Agreement, which shall be deemed incorporated into and forming part of the Agreement, prepared by the Contract Administrator and signed by the Owner and the Contractor stating their agreement upon:
1. a change in the Work;
 2. the method of adjustment or the amount of the adjustment in the Contract Price, if any; and
 3. the extent of the adjustment in the Contract Time, if any.
- 14. City**
City means the City of Toronto. The words “City” or “City of Toronto” wherever used in the Agreement shall be regarded as synonymous.
- 15. Claims**
Claims means any and all actual, threatened or potential claims, demands, proceedings, complaints, grievances, actions, adjudications, litigation, applications, suits, causes of action, orders, charges, arbitrations or other similar process, of whatsoever kind or nature (whether civil, administrative, regulatory, arbitral or otherwise), and Losses in respect of the foregoing matters.
- 16. Claim Notice**
Claim Notice has the meaning set out in GC 7.7.1.
- 17. Commencement Date**
Commencement Date means the commencement date for the performance of the Work as set out in row C.2 of the Information Sheet, or if no such date is set out, the date described in the Notice in Writing issued by the Owner to the Contractor, pursuant to GC 3.1.6 directing the Contractor to commence the performance of the Work.
- 18. Confidential Information**
Confidential Information means any and all (as the context requires) information of the disclosing party (including information in respect of or in connection with the Project or the performance of the Work) that is confidential to the disclosing party, or would reasonably be considered confidential, and that is disclosed orally or in writing by or on behalf of the disclosing party, to the receiving party pursuant to the Agreement, including

Construction Agreement

Schedule C – Definitions

during the performance of the Work, regardless of whether the Information is specifically identified or marked as “Confidential”, “Restricted” or “Secret”. For the purposes of the Agreement, all Personal Information shall constitute Confidential Information.

19. Conflict of Interest

Conflict of Interest means any situation or circumstance where in relation to the performance of its obligations under the Agreement, the Contractor’s other commitments, relationships or financial interests:

1. could or could be seen to exercise an improper influence over the objective, unbiased and impartial exercise of its independent judgment; or
2. could or could be seen to compromise, impair or be incompatible with the effective performance of its contractual obligations.

20. Construction Act

Construction Act means the *Construction Act*, RSO 1990, c. C 30.

21. Construction Equipment

Construction Equipment means all tools, machinery and equipment, either operated or not operated, that is required for preparing, fabricating, conveying, erecting, or otherwise performing the Work but is not incorporated into the Work.

22. Construction Schedule

Construction Schedule has the meaning set out in GC 3.5.1.1.

23. Contemplated Change Order

Contemplated Change Order has the meaning set out in GC 7.2.1.

24. Contract Administrator

Contract Administrator means the Person designated by the Owner in row A.4 of the Information Sheet to be the Owner’s day to day administrator for the purposes of the Agreement or such other Person as may be designated by the Owner, from time to time. The words “Engineer”, “Architect” or “Consultant” wherever used in the Agreement shall be regarded as synonymous with the Contract Administrator, unless identified otherwise in row A.4 of the Information Sheet or if the Owner notifies the Contractor otherwise in writing.

25. Contract Price

Contract Price has the meaning set out in paragraph 2.1 of Section 2 of the Agreement – CONTRACT PRICE.

26. Contract Time

Contract Time means the time stipulated in paragraph 1.3 of Section 1 of the Agreement - THE WORK from the Commencement Date to the Scheduled Date for Substantial Performance of the Work.

Construction Agreement Schedule C – Definitions

- 27. Contractor**
Contractor means the Person identified as such on page 1 of the Agreement. The term Contractor means the Contractor or the Contractor's authorized representative as designated to the Owner in writing.
- 28. Contractor Parties**
Contractor Parties means the Contractor, Subcontractors, Suppliers and Sub-subcontractors and their respective Personnel.
- 29. Contractor Project Manager**
Contractor Project Manager has the meaning set out in GC 3.7.3.1.
- 30. Contractor Records**
Contractor Records means the Contractor's books, payrolls, accounts, invoices, purchase orders, receipts or other information or documentation.
- 31. Contractor Site Supervisor**
Contractor Site Supervisor has the meaning set out in GC 3.7.3.2.
- 32. Contractual Holdback**
Contractual Holdback has the meaning set out in GC 8.4.1.
- 33. Contractor Prepared Documents**
Contractor Prepared Documents has the meaning set out in GC 13.3.1.
- 34. Current Schedule**
Current Schedule means the Contractor's most up-to-date working schedule, prepared based on the Construction Schedule, indicating for a specific reporting period the actual progress of the Work and forecasting of future progress and performance to complete the Work.
- 35. Daily Contractor Work Records**
Daily Contractor Work Records mean daily Contractor Records detailing labour (including the number and categories of Personnel and hours worked or on standby) and Construction Equipment (including types and quantities) employed and Product (including descriptions and quantities) used.
- 36. Deficiency or Deficient**
Deficiency or Deficient means any aspect of the Work (including Products) that fails to comply with, or conform to, the requirements of the Agreement including Laws and the Standard of Care, whether or not such non-compliance or non-conformances occur, or are discovered, prior to or during the Warranty Period. Deficiency or Deficient includes deficiencies in application, engineering, manufacture, installation, construction, workmanship or materials (to the extent the Work includes such elements) and deficiencies in Products.
- 37. Delay Liquidated Damages**
Delay Liquidated Damages has the meaning set out in GC 7.6.1.

Construction Agreement Schedule C – Definitions

38. Dispute

Dispute means all disputes between the parties arising out of or in connection with the Agreement including as to:

1. the interpretation, application or administration of the Agreement;
2. findings or determinations under the Agreement, including under GC 7.7.6; or
3. the performance of the Work.

39. Drawings

Drawings means the graphic and pictorial portions of the Agreement as attached or listed in Schedule H – Drawings and Specifications or elsewhere in the Agreement wherever located and whenever issued, showing the design, location and dimensions of the Work, generally including plans, elevations, sections, details, and diagrams, as the same may be amended, supplemented or replaced from time to time by the Owner.

40. Effective Date

Effective Date means the effective date of the Agreement as set out in row C.1 of the Information Sheet.

41. Equivalent OHS Certification

Equivalent OHS Certification means an occupational health and safety certification issued to qualifying firms by an independent third-party organization and accepted by the Owner (in the Owner's sole discretion) as equivalent to the Certificate of Recognition (COR™).

42. Estimate of Units

Estimate of Units means an estimate of the total units performed during the identified period for each item of the Unit Price Work, as may be amended by the Contract Administrator or Owner Representative.

43. Estimate of Units for Completion

Estimate of Units for Completion means the Estimate of Units as of the Effective Date for the total performance of the applicable item of Unit Price Work, as may be set out in the Pricing Form.

44. Extended Warranty Periods

Extended Warranty Periods has the meaning set out in GC 9.3.6.

45. Fair Wage Policy

Fair Wage Policy means the Owner's Fair Wage Policy, if any such policy is identified in Schedule F - Owner Policies, Procedures, By-Laws and Other Requirements.

46. Final Acceptance Certificate

Final Acceptance Certificate has the meaning set out in GC 5.8.1.

47. Fixed Price

Fixed Price means the fixed price for the Fixed Price Work set out in the Pricing Form, and as may be adjusted by Change Order.

Construction Agreement

Schedule C – Definitions

- 48. Fixed Price Work**
Fixed Price Work means the portion of the Work paid for on a Fixed Price basis.
- 49. GC**
GC means the General Conditions.
- 50. Governmental Authority**
Governmental Authority means any federal, provincial or municipal government, parliament or legislature, or any regulatory authority, agency, tribunal, commission, board or department of any such government, parliament or legislature, or any court or other law, regulation or rule-making entity, each having jurisdiction in the relevant circumstances, including, for clarity, any Person acting under the authority of any Governmental Authority and, with respect to taxes, whether domestic or foreign.
- 51. Hazardous Material**
Hazardous Material means any contaminant, pollutant, dangerous substance, potentially dangerous substance, noxious substance, toxic substance, hazardous waste, flammable material, explosive material, radioactive material, urea formaldehyde foam insulation, asbestos, polychlorinated biphenyls, coal tar and any other biological or chemical agent, substance or material named, described, declared or defined to be hazardous, toxic, or a contaminant or pollutant in, or pursuant to, any applicable Laws.
- 52. Highway**
Highway means a common and public highway, any part of which is intended for or used by the general public for the passage of vehicles and includes the area between the lateral property lines thereof.
- 53. Indemnitees**
Indemnitees has the meaning set out in GC 9.1.1.
- 54. Invoice Period**
Unless otherwise specified in row B.9 of the Information Sheet, Invoice Period means the one-month long period which commences on the Commencement Date and ends on the day prior to the same date as the Commencement Date in the next successive calendar month and each subsequent one-month long period thereafter.
- 55. Key Work Milestones**
Key Work Milestones means the major milestones for the performance of the Work as set out in row C.3 of the Information Sheet, if any, as such milestones may be revised by Change Order or Change Directive.
- 56. Laws**
Laws means all:
1. laws, orders-in-council, by-laws, codes, rules, regulations and statutes of any Governmental Authority;
 2. orders, decisions, judgments, injunctions, decrees, awards, directives, rulings and writs of any court, tribunal, arbitrator, Governmental Authority or other Person having jurisdiction;

Construction Agreement

Schedule C – Definitions

3. legally enforceable consents, approvals, policies and guidelines of any Governmental Authority; and

4. any requirements under or prescribed by applicable common law,

which are applicable to the Owner, Contractor, the Project, Site, Work or obligations under the Agreement.

57. Lien Holdback

Lien Holdback means the ten percent (10%) holdback retained pursuant to Part IV of the Construction Act.

58. Losses

Losses means any and all losses, debts, expenses, liabilities, damages, obligations, payments, fines and costs.

59. Major Item

Major Item means any item of Unit Price Work that has a value, calculated on the basis of its Estimate of Units for Completion multiplied by its Unit Price, which is equal to or greater than the lesser of:

1. \$100,000; and

2. 5% of the estimated Total Price of Unit Price Work (calculated using the Estimate of Units for Completion for all items of Unit Price Work).

60. MFIPPA

MFIPPA means the *Municipal Freedom of Information and Protection of Privacy Act*.

61. Notice in Writing

A Notice in Writing means a written communication between the parties or between them and the Contract Administrator that is transmitted in accordance with the provisions of GC 1.6.1 and GC 1.6.2.

62. Notice of Adjudication

Notice of Adjudication means a written notice of Adjudication, which:

1. complies with Section 13.7(1) of the Construction Act; and

2. is substantially in the form attached as Form 4 of Schedule G – Forms, including the submission of all applicable attachments.

63. Notice of Negotiations

Notice of Negotiations has the meaning set out in GC 12.3.1.

64. OHSA

OHSA means the *Occupational Health and Safety Act (Ontario)*.

65. OPS

OPS means the Ontario Provincial Standards.

Construction Agreement Schedule C – Definitions

- 66. Other Work**
Other Work has the meaning set out in GC 4.2.1.3.
- 67. Owner**
The Owner means the City of Toronto or its agency, board or commission as more particularly set out on page 1 of the Agreement.
- 68. Owner Documents**
Owner Documents means, collectively, the Owner Prepared Documents and Contractor Prepared Documents.
- 69. Owner Prepared Documents**
Owner Prepared Documents has the meaning set out in GC 1.1.11.
- 70. Owner Representative**
The Owner Representative means the Person designated by the Owner in row A.5 of the Information Sheet to have the authority to bind the Owner for the purposes of the Agreement or such other Person as may be designated by the Owner, from time to time.
- 71. Owner Supplied Material**
Owner Supplied Material means the material and/or equipment identified or referenced in the Drawings, Specifications or elsewhere in the Agreement as supplied by the Owner for incorporation into the Project, which is to be installed, tested, commissioned and otherwise dealt with, as applicable, by the Contractor in accordance with the Agreement.
- 72. Owner's Policies, Procedures and By-laws**
Owner's Policies, Procedures and By-Laws means the policies and procedures of the Owner and the by-laws of the City of Toronto, as may be amended, supplemented or replaced from time to time, including the policies, procedures and by-laws referenced in Schedule F - Owner Policies, Procedures, By-Laws and Other Requirements.
- 73. Person**
Person means any individual, partnership, limited partnership, joint venture, syndicate, company or corporation with or without share capital, trust, trustee, executor, administrator or other legal personal representative, Governmental Authority or entity however designated or constituted.
- 74. Personal Information**
Personal Information means all information captured by the definition of "personal information" contained in MFIPPA, regardless of whether MFIPPA is applicable to such information.
- 75. Personnel**
Personnel means with respect to a Person, its employees, invitees, directors, officers, representatives and agents, and any other person for whom the Person is directly or indirectly responsible under contract or law.
- 76. Pricing Form**
Pricing Form means the pricing form set out in Schedule B – Pricing Form.

Construction Agreement

Schedule C – Definitions

- 77. Procurement Process**
Procurement Process has the meaning set out in the recitals to the Agreement.
- 78. Product**
Product or Products means products, goods, material, machinery, devices, equipment, and fixtures forming the Work or any part thereof, but does not include Construction Equipment and Owner Supplied Material.
- 79. Project**
Project means the project as described in row A.1 of the Information Sheet, of which the Work may be the whole or a part.
- 80. Proper Invoice**
Proper Invoice means an invoice from the Contractor to the Owner on account as provided in 5.2 - OWNER'S OBLIGATION TO PAY, which is in compliance with the requirements of 5.3.
- 81. Provide**
Provide means to supply and install.
- 82. Provisional Allowance**
Provisional Allowance means the allowances, if any, identified in a schedule of prices in the Pricing Form for alterations, extras and deductions. Provisional Allowance items include overhead and profit.
- 83. QA/QC Plan**
QA/QC Plan has the meaning set out in GC 3.13.2.
- 84. Recovery Plan**
Recovery Plan has the meaning set out in GC 7.5.6.1.
- 85. Rules**
Rules means the *Rules of Civil Procedure*, RRO 1990, Reg 194.
- 86. Scheduled Date for Substantial Performance of the Work**
Scheduled Date for Substantial Performance of the Work means the scheduled date for Substantial Performance of the Work as set out in row C.4 of the Information Sheet, or if no such date is set out, the number of Calendar Days or Working Days after the Commencement Date specified in row C.4 of the Information Sheet.
- 87. Scheduled Date for Total Performance of the Work**
Scheduled Date for Total Performance of the Work means the scheduled date for Total Performance of the Work as set out in row C.5 of the Information Sheet, or if no such date is set out, the number of Calendar Days or Working Days after the Commencement Date specified in row C.5 of the Information Sheet.

Construction Agreement Schedule C – Definitions

- 88. Schedules**
Schedules means the schedules to the Agreement listed in paragraph 3.1 of Section 3 of the Agreement – DOCUMENTS COMPRISING THE AGREEMENT and includes any appendices thereto.
- 89. Shop Drawings**
Shop Drawings means the drawings, diagrams, illustrations, schedules, performance charts, brochures, Product data, and other data which the Contractor provides to illustrate details of portions of the Work.
- 90. Site**
Site means the designated site or location of the Work identified in row A.2 of the Information Sheet.
- 91. Special Specification**
Special Specification means a Specification containing requirements specific to the Work that are not included in any Standard Specification or which are intended to amend, supplement or replace part or all of a Standard Specification, as the same may be amended, supplemented or replaced from time to time by the Owner.
- 92. Specifications**
Specifications means that portion of the Agreement as attached or listed in Schedule H – Drawings and Specifications or elsewhere in the Agreement, wherever located and whenever issued, consisting of the written descriptions, requirements, instructions and standards for Products, systems, performance, installation, workmanship, quality, and the services necessary for the performance of the Work, as the same may be amended, supplemented or replaced from time to time by the Owner.
- 93. Standard Drawing**
Standard Drawing means a Drawing listed in the Schedule H – Drawings and Specifications as a standard drawing, as the same may be amended, supplemented or replaced from time to time by the Owner. The City of Toronto's Standard Drawings can be found on-line at www.toronto.ca/ecs-standards. Any of the OPS' Standard Drawings can be acquired from the OPS. Information about OPS can be found at www.ops.on.ca.
- 94. Standard of Care**
Standard of Care has the meaning set out in GC 3.13.1.
- 95. Standard Specification**
Standard Specification means a Specification listed in Schedule H – Drawings and Specifications as a standard Specification, as the same may be amended, supplemented or replaced from time to time by the Owner. The City of Toronto's Standard Specifications can be found on-line at www.toronto.ca/ecs-standards. Any of the OPS' Standard Specifications can be acquired from the OPS.
- 96. Subcontractor**
Subcontractor means a Person having a direct contract with the Contractor to perform a part or parts of the Work at the Site.

Construction Agreement
Schedule C – Definitions

97. Subject Matter of Indemnity

Subject Matter of Indemnity has the meaning set out in GC 9.1.1.

98. Submittals

Submittals means documents or items required by the Agreement to be provided by the Contractor in accordance with the Agreement such as:

1. Shop Drawings, samples, models, mock-ups to indicate details or characteristics, before the portion of the Work that they represent can be incorporated into the Work; and
2. As-Built Drawings and manuals to provide instructions as to the operation and maintenance of the Work.

99. Substantial Performance of the Work

Substantial Performance of the Work means:

1. the requirements set out in the Construction Act for a contract to be “substantially performed” have been met, including the Work being ready for use. For clarity, the Work shall not be “ready for use” until it has satisfied all the requirements for “ready for use” in the Specifications or elsewhere in the Agreement; and
2. the Contractor has submitted to the Contract Administrator all items required by the Specifications for Substantial Performance of the Work.

100. Substitution

Substitution has the meaning set out in GC 3.9.4.2.

101. Sub-subcontractor

Sub-subcontractor means a Person having a direct contract with a Subcontractor or Supplier or any other subcontractor or supplier at any tier, to perform a part or parts of the Work, or to supply Products. For greater certainty, Sub-subcontractors do not include the Subcontractors or the Suppliers.

102. Supplemental Instruction

A Supplemental Instruction means an instruction issued in writing, not involving adjustment in the Contract Price or Contract Time, in the form of Specifications, Drawings, schedules, samples, models or written instructions, which are consistent with the intent of the Agreement and issued by the Contract Administrator to supplement the Agreement as required for the performance of the Work.

103. Supplier

Supplier means a Person having a direct contract with the Contractor to supply Products.

104. Temporary Work

Temporary Work means temporary supports, structures, facilities, services, and other temporary items, excluding Construction Equipment, required for the execution of the Work but not incorporated into the Work.

Construction Agreement
Schedule C – Definitions

- 105. Total Performance of the Work or Totally Performed**
Total Performance of the Work or Totally Performed means when the entire Work (except for the correction of Deficiencies that are identified after the receipt of the Proper Invoice for payment, in accordance with 5.7) has been fully and totally performed to the requirements of the Agreement (including completion in accordance with the Construction Act and the correction of all Deficiencies that were identified prior to the receipt of such Proper Invoice) as certified by the Contract Administrator in the certificate of payment issued to the Owner pursuant to GC 5.7.1.4.
- 106. Total Price of Unit Price Work**
Total Price of Unit Price Work means the aggregate amount of, for all items of Unit Price Work, the total units required by the Owner under the Agreement for each item of Unit Price Work multiplied by the Unit Price of each such item.
- 107. T&M Changes in the Work**
T&M Changes in the Work means changes in the Work performed on a time and material basis in accordance with Section 3 of Schedule E – Valuing Changes in the Work.
- 108. T&M Price**
T&M has the meaning set out in section 3.1 of Schedule E – Valuing Changes in the Work.
- 109. Unit Price**
Unit Price means the unit price for an item of Unit Price Work set out in the Pricing Form.
- 110. Unit Price Work**
Unit Price Work means the portion of the Work paid for on a Unit Price basis.
- 111. Utilities and Structures**
Utilities and Structures has the meaning set out in GC 4.1.4.1.
- 112. Value Added Taxes**
Value Added Taxes means such sum as shall be levied upon the Contract Price by the Federal or any Provincial or Territorial Government and is computed as a percentage of the Contract Price and includes the Goods and Services Tax, the Harmonized Sales Tax, and any similar tax, the collection of which have been imposed on the Contractor by the tax legislation.
- 113. Warranty Period**
Warranty Period means the warranty period under the Agreement in respect of the Work (except for the Extended Warranty Periods as described in GC 9.3.6), which is two (2) years from the date of Substantial Performance of the Work or such other period as may be specified in row C.6 of the Information Sheet or elsewhere in the Agreement.
- 114. Work**
The Work means the total construction, Products, installation, commissioning, checkout, start-up, testing and related services, deliverables and other obligations as set out in,

Construction Agreement
Schedule C – Definitions

required by, reasonably inferable from or described in the Agreement. For clarity, the Work does not include the supply of Owner Supplied Material.

115. Working Day

Unless otherwise specified in row C.7 of the Information Sheet, Working Day means a Calendar Day other than:

1. a Saturday, Sunday, statutory holiday that is observed by the construction industry in the area of the Site; or
2. a Calendar Day identified by the City of Toronto as a designated or statutory holiday.

116. WSIB

WSIB means the Workplace Safety & Insurance Board.

SCHEDULE D

GENERAL CONDITIONS

1. GENERAL PROVISIONS

1.1 INTERPRETATION

1.1.1 The intent of the Agreement is to include the labour, Products and services required for the performance and completion of the Work by the Contractor in accordance with the Agreement or properly inferable from them.

1.1.2 If, subsequent to the Effective Date, changes are made by the Owner to any Standard Specifications, Special Specifications, Standard Drawings or any other Drawing or Specification which affect the cost of the performance of the Work or Contract Time, any claim by the Contractor must be submitted in accordance with the requirements of 7.7 - CLAIMS PROCEDURE and the Owner may submit a change in accordance with the requirements of 7.1 – OWNER’S RIGHT TO MAKE CHANGES.

1.1.3 Subject to any rights or remedies which may be available to the Owner, nothing contained in the Agreement shall create any contractual relationship between:

- .1 the Owner and a Contractor Party performing any portion of the Work;
- .2 the Contract Administrator and a Contractor Party performing any portion of the Work; or
- .3 the Owner Representative and a Contractor Party performing any portion of the Work.

1.1.4 Words and abbreviations which have well known technical or trade meanings are used in the Agreement in accordance with such recognized meanings.

1.1.5 In the Agreement, unless the context otherwise requires, words importing the singular include the plural and vice versa and words importing gender include all gender.

1.1.6 Neither the organization of the Specifications nor the arrangement of Drawings shall control the Contractor in dividing the Work among Subcontractors and Suppliers.

1.1.7 Subject to GC 1.1.9, if there is an inconsistency or a conflict within the Agreement:

- .1 the order of priority of documents, from highest to lowest, shall be, unless otherwise provided for in row E.1 of the Information Sheet:
 - (1) any amendment to the Agreement made in accordance with the terms and conditions of the Agreement, shall take precedence only over those specific provisions of the Agreement expressly amended, in order of most recent date issued (if any),
 - (2) Schedule A - Information Sheet and Schedule B – Pricing Form,

Construction Agreement

Schedule D – General Conditions

- (3) the Agreement (excluding the Schedules),
 - (4) the Schedules of Agreement in the following order: Schedule F – Owner Policies, Procedures, By-Laws and Other Requirements, Schedule D – General Conditions and all remaining Schedules other than Schedule H – Drawings and Specifications,
 - (5) Supplemental Instructions,
 - (6) the summary of the Work as described in the Specifications,
 - (7) the Specifications (other than the summary of the Work and the material and finishing schedules in the Specifications),
 - (8) material and finishing schedules in the Drawings and Specifications,
 - (9) the Drawings (other than the material and finishing schedules in the Drawings),
 - (10) Construction Schedule, and
 - (11) any other document identified elsewhere in the Agreement as a document forming part of the Agreement
- .2 Drawings of larger scale shall govern over those of smaller scale of the same date;
 - .3 dimensions shown on Drawings shall govern over dimensions scaled from Drawings;
 - .4 detailed Drawings shall govern over general Drawings;
 - .5 later dated documents shall govern over earlier documents of the same type; and
 - .6 Special Specifications shall govern over Standard Specifications.
- 1.1.8 Subject to GC 1.1.9, if there is an inconsistency or a conflict within the contents of Standard Specifications and Standard Drawings, the order of priority from highest to lowest shall be:
- .1 City of Toronto Standard Specifications and City of Toronto Standard Drawings, including any amendments; then
 - .2 OPS Standard Specifications and OPS Standard Drawings, including any amendments; then
 - .3 other Standard Specifications and Standard Drawings referenced in the City of Toronto Standard Specifications and City of Toronto Standard Drawings or OPS Standard Specifications and OPS Standard Drawings, including, as applicable, those produced by Canadian Standards Association, Canadian General

Construction Agreement

Schedule D – General Conditions

Standards Board, American Society for Testing and Materials and American National Standards Institute.

- 1.1.9 Notwithstanding GC 1.1.7 and 1.1.8, any provision within the Agreement establishing a higher standard of safety, reliability, durability, performance, service or quality shall take precedence over a provision establishing a lower standard of safety, reliability, durability, performance, service or quality.
- 1.1.10 The Owner shall provide the Contractor, without charge, one (1) electronic copy and up to three (3) hard copies of the Agreement other than the specifications of Canadian, United States of America or internationally recognized standards associations (including the Standard Specifications and Standard Drawings), in which case, such documents are the responsibility of the Contractor to obtain as the case may be. If requested by the Contractor, the Owner shall provide additional copies and the Contractor shall be responsible for the cost of printing, handling and shipping.
- 1.1.11 All Specifications, Drawings, models and other applicable Agreement documents and any other correspondence, data, plans, drawings, specifications, reports, estimates, summaries, photographs, models, mock-ups, information and documentation in any form, and copies thereof, furnished by the Contract Administrator or the Owner (collectively, the “**Owner Prepared Documents**”) are not the property of the Contractor. All Owner Prepared Documents furnished by the Contract Administrator or Owner are to be used by the Contractor only with respect to the Work and are not to be used on other work. The Owner Prepared Documents are not to be copied or altered in any manner by the Contractor without the written authorization of the Contract Administrator or the Owner.
- 1.1.12 The Owner may issue to the Contractor one or more purchase orders in respect of the Work and/or Agreement. Any such purchase order shall be solely for the convenience of the Owner in administering its internal procedures, and notwithstanding any of the provisions set out in such purchase order, shall not create any binding obligations of either party or in any way be deemed to amend, restate, supplement or replace any of the Agreement or otherwise be considered to form a part of the Agreement.

1.2 ENTIRE AGREEMENT AND AMENDMENTS

- 1.2.1 The Agreement embodies and constitutes the sole and entire agreement between the parties hereto. There are no terms, obligations, covenants or conditions between the parties hereto, other than as contained herein. The Agreement is complementary and what is required by any:
- .1 part thereof shall be considered as being required by the whole; and
 - .2 one document forming a part of the Agreement shall be as binding as if required by all. The Agreement supersedes all prior negotiations, representations or agreements, either written or verbal, relating in any manner to the Work, including the documents from the Procurement Process.

Construction Agreement
Schedule D – General Conditions

1.2.2 The Agreement may be amended only as provided in the Agreement. No amendment of the Agreement shall be valid unless executed by an instrument in writing by the parties, except as provided for in the Agreement. Neither the Agreement, nor any term hereof, can be amended in whole or in part, except by such instrument in writing, except as provided for in the Agreement, and no subsequent verbal agreement shall have any validity whatsoever.

1.2.3 Unless expressly provided otherwise in the Agreement including GC 2.4.1:

.1 no verbal arrangement or agreement, relating to the Work, the Agreement or any other matter concerning the Agreement or Work, will be of any force or effect unless it is in writing and signed by duly authorized representative of the Owner; and

.2 the Owner and the Contract Administrator shall not be bound by any verbal communication or representation or conduct whatsoever, including any instruction, amendment or clarification of the Agreement, or any representation, information, advice, inference or suggestion, from any Person (including but not limited to an elected official, Personnel, independent contractor or any other Person acting on the behalf of or at the direction of the Owner or Owner Representative or other representative of the Owner including the Contract Administrator) concerning the Agreement, or any other matter concerning the Agreement or Work. Where in the Agreement a reference is made to the express written agreement, approval or consent of the Owner or the Contract Administrator, it shall be understood that the Owner or the Contract Administrator, as applicable, shall not be deemed or construed to have agreed to any stipulation, specification, exclusion, limitation or other term or condition that deviates from or amends a provision set out in the Agreement, unless that deviation or amendment is expressly confirmed in the executed Agreement or in a written and express amendment to the Agreement by a duly authorized representative of the Owner.

1.3 LAW OF THE AGREEMENT AND INTERPRETATION

1.3.1 The laws of the Province of Ontario and the federal laws of Canada applicable therein shall govern the interpretation of the Agreement.

1.3.2 The phrase “includes”, “include” or “including” means “includes, without limitation” or “including” or “include, without limitation,”.

1.3.3 If any provision of the Agreement or its application to any party or circumstance is unenforceable, the provision shall be ineffective only to the extent of the unenforceability without: (.1) invalidating the remaining provisions of the Agreement; (.2) changing the fundamental nature of the obligations assumed by the parties; and (.3) affecting its application to other parties or circumstances.

1.3.4 Except as otherwise expressly provided for in the Agreement, any reference in the Agreement to a statute or code or rule promulgated under a statute or to any provision of a statute, code or rule promulgated under a statute shall be a reference to the statute, code, rule or provision, as amended, supplemented, re-enacted or

Construction Agreement

Schedule D – General Conditions

replaced from time to time. Any reference to a statute shall be a reference to the statute and its underlying regulations.

1.3.5 The terms of the Agreement, which expressly or by their nature are intended to survive the termination or discharge of the Agreement (including all indemnities, representations and warranties of the Contractor) shall survive such termination or discharge.

1.3.6 For the purposes of the Agreement, all documents and communications pertaining to the Agreement shall be in the English language.

1.4 RIGHTS AND REMEDIES

1.4.1 Except as expressly provided in the Agreement, the duties and obligations imposed by the Agreement and the rights and remedies available thereunder shall be in addition to and not a limitation of any duties, obligations, rights, and remedies otherwise imposed or available by Laws.

1.4.2 No act or failure to act by the Owner, the Contract Administrator or Contractor shall, except as may be specifically agreed:

- .1 constitute a waiver of any right or duty afforded any of them under the Agreement;
- .2 constitute an approval of or acquiescence in any breach, default or non-observance thereunder; or
- .3 operate as a waiver of any such right or duty of the Owner in respect of any continuing or subsequent default, breach or non-observance, or so as to defeat or affect in any way such right or duty in respect of any such continuing or subsequent default, breach or non-observance.

1.4.3 The Contractor acknowledges and agrees that the exercise by the Owner of any of its rights or remedies under the Agreement, including the Owner's rights and remedies under 11. DEFAULT, TERMINATION AND SUSPENSION shall not result in irreparable harm to the Contractor and the Contractor shall not seek any order for injunctive relief, specific performance, certiorari or mandamus from any arbitral tribunal or court of law in relation to such exercise.

1.5 ASSIGNMENT AND SUCCESSION

1.5.1 The Contractor shall not assign the Agreement, either in whole or in part, without the written consent of the Owner, which consent may be withheld or given subject to such terms and conditions as the Owner deems appropriate.

1.5.2 Notwithstanding the foregoing, the Contractor acknowledges and agrees that the Owner may assign the Agreement, or any portion thereof, without the consent of the Contractor.

Construction Agreement
Schedule D – General Conditions

1.5.3 The Agreement shall enure to the benefit of and be binding upon the parties hereto, their respective heirs, legal representatives, successors, and permitted assigns.

1.6 RECEIPT OF AND ADDRESSES FOR NOTICES AND DOCUMENTATION

1.6.1 Subject to GC 1.6.3, the parties agree that any Notice in Writing required to be given or that may be given under this Agreement shall be given in writing only by one of the following methods:

- .1 electronic mail to the name and address set out in row A.3 of the Information Sheet, including the name and telephone number of a person at the sender to contact in the event of a transmission problem;
- .2 delivery by hand to the name and address set out in row A.3 of the Information Sheet;
- .3 registered mail to the name and address set out in row A.3 of the Information Sheet; or
- .4 courier to the name and address set out set out in row A.3 of the Information Sheet.

1.6.2 For purposes of this Agreement:

- .1 a Notice in Writing sent by electronic mail which is transmitted prior to 5:00 p.m. on a Working Day, shall be deemed to have been received by the recipient on that Calendar Day, or on the next Working Day, if delivered after 5:00 p.m. or on a Calendar Day which is not a Working Day; provided that during the transmission of which no indication of failure of receipt is communicated to the sender;
- .2 a Notice in Writing delivered by hand or courier prior to 5:00 p.m. on a Working Day, shall be deemed to have been received by the recipient on such Calendar Day of delivery, or on the next Working Day, if delivered after 5:00 p.m. or on a Calendar Day which is not a Working Day; or
- .3 a Notice in Writing which is sent by registered mail is deemed to be received by the party to whom the Notice in Writing is addressed on the fifth (5th) Working Day after the date of mailing, where the date appearing on the postal registration receipt shall be deemed conclusively to be the date of mailing.

1.6.3 Notwithstanding GC 1.6.1, the parties agree that documents and notices required to be given or that may be given under the Construction Act shall be given in writing by a means or method permitted for under the Construction Act unless such means or methods are stipulated elsewhere in the Agreement.

1.6.4 Either Party may change its address or other contact particulars as set out in GC 1.6.1 by giving a Notice in Writing to the other in the manner set out in GC 1.6.1.

1.7 CONFLICTS OF INTEREST

1.7.1 The Contractor shall:

- .1 avoid any Conflict of Interest in the performance of its contractual obligations;
- .2 disclose to the Owner without delay any actual or potential Conflict of Interest that arises during the performance of its contractual obligations;
- .3 comply with any reasonable requirements prescribed by the Owner to resolve any Conflict of Interest; and
- .4 comply with the other requirements of Chapter 195, Purchasing, of the Toronto Municipal Code in respect of conflicts of interest and unfair advantages (as defined therein).

For clarity, the Owner shall be entitled to exercise any rights or remedies which may be available to the City of Toronto pursuant to Chapter 195, Purchasing, of the Toronto Municipal Code in respect of conflicts of interest and unfair advantages (as defined therein).

1.8 MISCELLANEOUS

1.8.1 The Contractor is an independent contractor and is not an agent of the Owner.

1.8.2 The Contractor shall not publish, issue or make any statements or news release, electronic, graphic, pictorial or otherwise, concerning the Agreement, the Work, or the Project, without the express prior written consent of the Owner.

2. ADMINISTRATION OF THE AGREEMENT

2.1 AUTHORITY OF THE CONTRACT ADMINISTRATOR AND THE OWNER REPRESENTATIVE

2.1.1 The Contract Administrator shall have no authority to bind the Owner, unless otherwise provided for in writing by the Owner.

2.1.2 The Owner Representative shall be the Owner's representative during construction and until the issuance by the Contract Administrator of the Final Acceptance Certificate. Only the Owner Representative shall have the authority to bind the Owner for the purposes of the Agreement. The Owner Representative may be a Personnel of the Owner or any other Person including the same Person as the Contract Administrator.

2.1.3 The Owner Representative will execute Change Orders and Change Directives as provided in 7.2 - CHANGE ORDER and 7.3 - CHANGE DIRECTIVE.

2.1.4 All instructions and documents issued to the Contractor will be issued by the Contract Administrator or the Owner Representative, as the case may be, and the Contractor shall not recognize instructions issued by other Personnel of the Owner or any other

Construction Agreement

Schedule D – General Conditions

document issued by other Personnel of the Owner as amending, supplementing or clarifying the Agreement.

2.2 ROLE OF THE CONTRACT ADMINISTRATOR

- 2.2.1 The Contract Administrator will provide administration of the Agreement as described in the Agreement. The Contract Administrator may be a third party, including an architect or engineer or other consultant, or a Personnel of the Owner.
- 2.2.2 The Contract Administrator will visit the Site at intervals appropriate to the progress of construction to become familiar with the progress and quality of the Work and to determine if the Work is proceeding in general conformity with the Agreement.
- 2.2.3 If the Owner and the Contract Administrator agree, the Contract Administrator will provide at the Site, one or more project representatives to assist in carrying out the Contract Administrator's responsibilities.
- 2.2.4 The Contract Administrator will promptly inform the Owner of the date of receipt of Proper Invoices as provided in 5.4 - PROGRESS PAYMENT.
- 2.2.5 The Contract Administrator will review the Work for its conformity with the Agreement and record the necessary data to establish payment quantities under the schedule of quantities and Unit Prices for Unit Price Work or to assess the value of the Work completed in the case of Fixed Price Work. Based on such records and the Contract Administrator's evaluation of the Proper Invoices, the Contract Administrator will determine the amounts owing to the Contractor under the Agreement and will issue certificates for payment as provided in 5. CONTRACT PRICE AND PAYMENT.
- 2.2.6 The Contract Administrator will not be responsible for and will not have control, charge or supervision of construction means, methods, techniques, sequences, or procedures, or for health and safety precautions and programs required in connection with the Work in accordance with the applicable health and safety Laws or general construction practice. The Contract Administrator will not be responsible for the Contractor's failure to carry out the Work in accordance with the Agreement. The Contract Administrator will not have control over, charge of or be responsible for the acts or omissions of the Contractor Parties performing portions of the Work.
- 2.2.7 The Contract Administrator will be, in the first instance, the interpreter of the requirements of the Agreement.
- 2.2.8 Matters in question relating to the performance of the Work or the interpretation of the Agreement shall be initially referred in writing to the Contract Administrator by the party raising the question for interpretations and findings and copied to the other party.
- 2.2.9 Interpretations and findings of the Contract Administrator shall be consistent with the intent of the Agreement. In making such interpretations and findings, the Contract Administrator will not show partiality to either the Owner or the Contractor.

Construction Agreement

Schedule D – General Conditions

- 2.2.10 The Contract Administrator’s interpretations and findings will be given in writing to the parties within a reasonable time and shall be subject to either party’s right to dispute such interpretations and findings in accordance with 12. DISPUTE RESOLUTION.
- 2.2.11 The Contract Administrator will investigate all Claim Notices made by the Contractor pursuant to 7.7 - CLAIMS PROCEDURE and will make findings as set out in 7.7 - CLAIMS PROCEDURE and issue appropriate instructions.
- 2.2.12 During the progress of the Work the Contract Administrator will provide Supplemental Instructions to the Contractor with reasonable promptness or in accordance with a schedule for such Supplemental Instructions agreed to by the Contract Administrator and the Contractor.
- 2.2.13 The Contract Administrator will review and take appropriate action upon Shop Drawings, samples and other Contractor’s Submittals and submissions, in accordance with the Agreement.
- 2.2.14 The Contract Administrator will prepare Change Orders and Change Directives as provided in 7.2 - CHANGE ORDER and 7.3 - CHANGE DIRECTIVE. For clarity, Change Directives must be signed by the Owner and Change Orders must be signed by both the Owner and the Contractor.
- 2.2.15 The Contract Administrator and the Contractor will jointly conduct reviews of the Work to determine the date of Substantial Performance of the Work and Total Performance of the Work as provided in 5.5 - SUBSTANTIAL PERFORMANCE OF THE WORK and 5.7 - PAYMENTS UPON TOTAL PERFORMANCE OF THE WORK, respectively.
- 2.2.16 All certificates issued by the Contract Administrator will be to the best of the Contract Administrator’s knowledge, information and belief. By issuing any certificate, the Contract Administrator does not guarantee the Work is correct or complete.
- 2.2.17 The Contract Administrator will receive and review written warranties and related documents required by the Agreement and provided by the Contractor.
- 2.2.18 If the Contract Administrator observes that any Personnel of the Contractor, Subcontractors, Suppliers or Sub-subcontractors is potentially incompetent, disorderly or a detriment to the Project, then the Contract Administrator shall provide Notice in Writing to the Contractor and the Contractor, at the Contractor’s cost and without any extension of the Contract Time, shall, in accordance with its obligations under the Agreement, immediately remove such Personnel from the Site if the Contractor determines that such Personnel should be immediately removed from the Site. If such Personnel is removed, the Contractor, at the Contractor's cost and without any extension of the Contract Time, shall provide replacement Personnel acceptable to the Contract Administrator. Such incompetent, disorderly or detrimental Personnel shall not return to the Site without the prior written consent of the Contract Administrator.
- 2.2.19 The Contract Administrator shall have the authority to temporarily suspend the Work for such reasonable time as may be necessary, for the following reasons:

Construction Agreement

Schedule D – General Conditions

- .1 for the Contractor to remedy its non-compliance with the provisions of the Agreement;
- .2 to facilitate the checking of any portion of the Contractor's construction layout;
- .3 to facilitate the inspection of any portion of the Work by the Contract Administrator.

The Contractor shall not be entitled to any increase in the Contract Price or extension of the Contract Time in these circumstances.

2.3 REVIEW AND INSPECTION OF THE WORK

2.3.1 The Owner and the Contract Administrator shall have access to the Work at all times. The Contractor shall provide sufficient, safe and proper facilities and assistance at all times for the review of the Work by the Contract Administrator and Owner and the inspection of the Work by Governmental Authorities and quasi-governmental authorities. If parts of the Work are in preparation at locations other than the Site, the Owner and the Contract Administrator shall be given access to such Work whenever it is in progress.

2.3.2 If tests, inspections or approvals for the Work are required by the Agreement, or by the Contract Administrator's instructions, or by Laws, the Contractor shall give the Contract Administrator no less than three (3) Working Days notification of when the Work will be ready for review and inspection and make available for inspection or testing a sample of any Product. All inspection, sampling, and testing of Products shall be carried out on a random basis in accordance with the standard inspection or testing methods required for the Product. The Contractor shall arrange for and shall give the Contract Administrator reasonable notification of the date and time of inspections by other authorities and shall notify the Contract Administrator of the sources of supply of Products sufficiently in advance of the Product shipping dates to enable the Contract Administrator to perform any required inspection, sampling and testing. The Contractor shall obtain for the Contract Administrator the right to enter onto the premises of the Product manufacturer or supplier to carry out such inspection, sampling and testing. The Owner shall not be responsible for any delays to the performance of the Work where the Contractor fails to give sufficient advance notice to the Contract Administrator to enable the Contract Administrator to carry out the required inspection, sampling and testing.

2.3.3 The Contractor shall furnish promptly to the Contract Administrator, and in no event later than within fourteen (14) Calendar Days after receipt thereof, two copies of certificates and inspection reports relating to the Work prepared by Governmental Authorities and quasi-governmental authorities.

2.3.4 If the Contractor covers, or permits to be covered, Work that has been designated for special tests, inspections or approvals before such special tests, inspections or approvals are made, given or completed, the Contractor shall, if so directed, uncover such Work, have the inspections or tests satisfactorily completed, and make good covering Work at the Contractor's cost and without any extension of the Contract Time.

Construction Agreement

Schedule D – General Conditions

- 2.3.5 Subject to GC 2.3.4, the Contract Administrator may order any portion or portions of the Work to be examined to confirm that such Work is in accordance with the requirements of the Agreement. If the Work is not in accordance with the requirements of the Agreement, the Contractor shall correct the Work and pay the cost of examination and correction and without any extension of the Contract Time. If the Work is in accordance with the requirements of the Agreement, the Owner shall pay the cost of examination and restoration.
- 2.3.6 The Contractor shall pay the cost of making any test or inspection whether to be performed by the Contractor, Contract Administrator, Owner, Governmental Authorities or quasi-governmental authorities, including the cost of samples required for such test or inspection, if such test or inspection is required by the Agreement or is required by Laws.
- 2.3.7 If any portion or portions of the Work is found to be Deficient in initial tests or inspections as determined by the Contractor, Owner, Contract Administrator, Governmental Authorities or quasi-governmental authorities, the costs of re-testing and re-inspections shall be borne by the Contractor and with no adjustment in the Contract Price or any extension of the Contract Time.
- 2.3.8 The Contractor shall provide any documentation requested by the Owner, where that documentation relates to any of the Work. The Contractor shall ensure that all such documentation is provided no later than ten (10) Calendar Days following the receipt of any such request.
- 2.3.9 The Contract Administrator and Owner will each have authority to reject any portion of the Work which in the Contract Administrator's or Owner's opinion is Deficient. Whenever the Contract Administrator or Owner considers it necessary or advisable, the Contract Administrator or Owner will have authority to require inspection or testing of Work, whether or not such Work is fabricated, installed or completed.
- 2.3.10 Any review, inspection, comment, acceptance, approval, audit, survey or rejection, or failure to review, inspect, comment, accept, approve, audit, survey or reject, by the Owner or the Contract Administrator of the Work (including Products or any documents prepared by the Contractor, Subcontractors, Suppliers or Sub-subcontractors, in whole or in part) or the issuance of any certificates or the making of any payment by the Owner or the presence of the Owner or the Contract Administrator at the Site or the receipt or taking delivery by the Owner of any Products, shall not:
- .1 constitute acceptance of the Work (including Products) or any Deficiencies or relieve the Contractor of its responsibility therefor;
 - .2 impose on the Owner or the Contract Administrator the responsibility for the sequencing, scheduling or progress of the Work;
 - .3 be deemed to confirm that any schedule is a reasonable plan for providing the Work in accordance with the relevant Construction Schedule;

Construction Agreement

Schedule D – General Conditions

- .4 constitute an approval, disapproval, endorsement or confirmation of any Work (including Products or any document prepared by the Contractor, Subcontractors, Suppliers or Sub-subcontractors, in whole or in part) or an acknowledgment by the Owner or the Contract Administrator that any Work (including Products and such documents) satisfies the requirements of the Agreement;
- .5 affect or change the Contractor's obligation to perform the Work in accordance with the Agreement and relieve the Contractor from any liability arising from its failure to properly perform the Work;
- .6 give rise to any duty or responsibility of the Owner or the Contract Administrator to the Contractor Parties performing any of the Work; or
- .7 except as otherwise provided in the Agreement, have the effect of waiving or diminishing any obligation of, or limiting any liability of, the Contractor or of transferring any obligation under the Agreement from the Contractor to the Owner or the Contract Administrator or otherwise have the effect of amending the Agreement.

Any review or approval by the Owner and/or Contract Administrator is intended only to ascertain that the document or the performance of the Contractor's duties, liabilities, responsibilities or obligations under the Agreement including the Work generally meets the intention of the Agreement and is not an assurance or confirmation of the adequacy, quality, fitness, suitability or correctness of the Contractor's obligations, responsibilities, duties and liabilities under the Agreement including the Work, for which the Contractor is solely responsible in accordance with the Agreement.

- 2.3.11 Any Deficiencies arising from Work done by the Contractor without consulting the Contract Administrator or the Owner when the Work required the acceptance of or review with same, or when the Contractor should have sought the acceptance of Contract Administrator or Owner, shall be corrected at the cost of the Contractor (without increase in the Fixed Price or Unit Prices) and without any extension of the Contract Time.

2.4 EMERGENCY SITUATIONS

- 2.4.1 If the Contract Administrator or Owner determines, in their sole and absolute discretion, that there is an emergency situation, then the Contract Administrator or Owner, as applicable, may instruct the Contractor to take action to remedy the situation verbally or in writing. If such instruction is verbal, the Contract Administrator or Owner, as applicable, shall provide timely confirmation of such instruction in writing. If the Contractor does not take timely action, or if the Contractor is not available, the Contract Administrator or Owner may direct others to remedy the situation. If the emergency situation is the fault of the Contractor, the remedial Work shall be done at the cost of the Contractor and without any extension of the Contract Time.

Construction Agreement

Schedule D – General Conditions

2.5 DEFICIENCIES

- 2.5.1 The Contractor shall promptly correct all Deficiencies, including Deficiencies that have been identified by the Contract Administrator and/or Owner, at the Contractor's cost (and with no adjustment in the Fixed Price or Unit Prices) and without any extension of the Contract Time, whether or not the Deficiency has been incorporated in the Work and whether or not the Deficiency is the result of poor workmanship, use of Deficient products or damage through carelessness or other act or omission of a Contractor Personnel, provided that:
- .1 the Contractor shall correct, in a manner acceptable to the Owner or the Contract Administrator, all Deficiencies, whether or not they are specifically identified by the Contract Administrator or Owner; and
 - .2 the Contractor shall prioritize the correction of any Deficiencies which, in the sole discretion of the Owner, adversely affects the work or operations of the Owner or other contractors or there is a risk of bodily injury to any individual or physical loss of or damage to property.
- 2.5.2 The Contractor shall remove rejected Products from the Site expeditiously after the notification to that effect from the Contract Administrator or Owner. Where the Contractor fails to comply with such notice, the Contract Administrator or Owner may cause the rejected Products to be removed from the Site and disposed of in what the Contract Administrator or Owner considers to be the most appropriate manner, and the Contractor shall pay the costs of disposal.
- 2.5.3 The Contractor shall promptly make good damage or destruction to the Owner's or other contractors' work, other property of the Owner, or any other property as a result of Deficiencies or the correction of Deficiencies at the Contractor's cost (and with no adjustment in the Fixed Price or Unit Prices) and without any extension of the Contract Time.
- 2.5.4 If the Contractor fails to promptly carry out the correction of Deficiencies or make good damage or destruction to the Owner's or other contractors' work, other property of the Owner, or any other property as required by this 2.5 – DEFICIENCIES, the Owner may correct the Deficiencies or make good such work or property and hold the Contractor responsible for all costs thereof.
- 2.5.5 If in the opinion of the Contract Administrator or Owner it is not expedient to correct a Deficiency, the Owner may, in accordance with 5.10 – OWNER'S SET-OFF, set-off the greater of (i) the difference in value between the Work as performed and that called for by the Agreement and (ii) the cost to correct such Deficiency. If the Owner and the Contractor do not agree on the difference in value or the cost to correct such Deficiency, they shall refer the matter to the Contract Administrator for determination.
- 2.5.6 No payment by the Owner under the Agreement nor partial or entire use or occupancy of the Work by the Owner shall constitute an acceptance of any portion of the Work (including Products) which is Deficient.

2.6 CONTRACTOR RECORDS

- 2.6.1 Prior to the issuance of the final certificate for payment, and thereafter until the later of two (2) years after the end of the Warranty Period, or all Claims in respect of the Agreement being settled, the Contractor shall maintain and keep accurate Contractor Records in respect of Work (including in respect of Fixed Price Work, Construction Equipment, Products, component costs reflecting the taxes and customs duties, including excise taxes and changes in the Work). Without limiting the generality of the foregoing, the Contractor Records shall be of sufficient detail to support the total cost of any Work (other than Fixed Price Work), changes in the Work, Cash Allowances expenditures and taxes and duties. For Fixed Price Work, the Contractor Records shall be of sufficient detail for the Owner to ascertain the Contractor's compliance with the Fair Wage Policy, if any.
- 2.6.2 The Contractor shall cause the Subcontractors, Suppliers and Sub-subcontractors, to:
- .1 maintain and keep accurate Contractor Records in respect of all items for which the Contractor is required by the Agreement to maintain and keep Contractor Records; and
 - .2 allow the Owner to inspect and audit such Contractor Records, for the same period of time.
- 2.6.3 Without limiting the generality of 13.3, the Owner may inspect and audit the Contractor Records at any time during the period in which the Contractor is required to maintain and keep such Contractor Records. The Contractor shall, at its cost, supply certified copies (and notarized if maintained outside of Ontario) of any part of the Contractor Records required whenever requested by the Owner.

3. EXECUTION OF THE WORK

3.1 CONTROL AND COMMENCEMENT OF THE WORK

- 3.1.1 The Contractor shall, and shall cause the Subcontractors, Suppliers and Sub-subcontractors to, perform the Work in accordance with the Agreement and comply with the Agreement. The Contractor shall have total control of the Work and shall effectively direct and supervise the Work so as to ensure conformity with the Agreement.
- 3.1.2 The Contractor shall be solely responsible for construction means, methods, techniques, sequences, and procedures and for co-ordinating the various parts of the Work under the Agreement, even if such means, methods, techniques, sequences or procedures are set out in the Owner Prepared Documents.
- 3.1.3 The Contractor shall not enter upon or occupy any property of a third party for any purpose, unless the Contractor has received prior written permission from the property owner.
- 3.1.4 Except for such Work as may be required by the Contract Administrator to maintain the Work in a safe and satisfactory condition or as otherwise expressly allowed by the

Construction Agreement

Schedule D – General Conditions

Agreement, the Contractor shall not carry on Work at the Site on Calendar Days other than Working Days without permission in writing from the Contract Administrator.

3.1.5 The Contractor shall, at all times and as part of the Work, fully assist, co-operate, consult and co-ordinate with the Contract Administrator, the Owner Representative and any other Persons retained or identified by the Owner which are related to or connected with the Project or performing work at or near the Site. The objective of such assistance, co-operation, consultation and co-ordination is to make certain the Work is properly co-ordinated with and integrated with the work, services and operations of such entities.

3.1.6 The Contractor shall not commence the Work or deliver anything to the Site prior to the Commencement Date. If no date is set out for the Commencement Date in row C.2 of the Information Sheet, the Owner shall be entitled to issue a Notice in Writing to the Contractor directing the Contractor to commence the performance of the Work on the date described therein.

3.2 SUPPLEMENTAL INSTRUCTIONS

3.2.1 The Contract Administrator may, during the progress of the Work, issue Supplemental Instructions, which shall be deemed incorporated into and forming part of the Agreement. Supplemental Instructions shall only be issued by the Contract Administrator.

3.2.2 Upon receipt of a Supplemental Instruction, the Contractor shall immediately proceed to perform the Work in accordance with such Supplemental Instruction and otherwise in accordance with the Agreement, unless the Contractor is of the opinion that such Supplemental Instructions require a change in the Contract Price and/or extension of the Contract Time, in which case the Contractor shall proceed in accordance with GC 3.2.3.

3.2.3 If the Contractor, after receiving Supplemental Instructions, is of an opinion that such Supplemental Instructions require a change in the Contract Price and/or extension of the Contract Time, then the Contractor shall promptly notify the Owner and Contract Administrator of such and submit a Claim Notice in accordance with the requirements of 7.7 - CLAIMS PROCEDURE. The Contractor shall not proceed with the Work in respect of such Supplemental Instruction until it has received further instruction from the Contract Administrator. If, pursuant to 7.7 - CLAIMS PROCEDURE it is subsequently determined that the Claim Notice in respect of such Supplemental Instructions is valid, then such determination shall be reflected in a Change Directive issued pursuant to 7.3 – CHANGE DIRECTIVE.

3.3 CONSTRUCTION BY OWNER OR OTHER CONTRACTORS

- 3.3.1 The Owner reserves the right to award separate contracts in connection with other parts of the Project to other contractors and to perform work with its Personnel. Such work by other contractors or Owner's Personnel may include utility relocation and surveying, testing, sampling and quality assurance estimates prior to, and possibly during, the Work.
- 3.3.2 Subject to and without limitation to 4.2 – HEALTH AND SAFETY, when separate contracts are awarded for other parts of the Project, or when work is performed by the Owner's Personnel, the Contractor shall:
- .1 co-ordinate, schedule and sequence the activities and work of other contractors and Owner's Personnel on the Project with the Work; and
 - .2 promptly report to the Contract Administrator in writing, and in no event later than within five (5) Working Days of discovery thereof, any apparent deficiencies in the work of other contractors or of the Owner's Personnel, where such work affects the proper execution of any portion of the Work, prior to proceeding with that portion of the Work. Failure by the Contractor to so report shall invalidate any Claims against the Owner by reason of deficiencies in the work of other contractors or Owner's Personnel except those deficiencies not then reasonably discoverable,
- 3.3.3 Where the Agreement identifies work to be performed by other contractors or the Owner's Personnel, the Contractor shall co-ordinate the Construction Schedule (and access to the Site) with the work of other contractors and the Owner's Personnel so as to mitigate the risk of delay and disruption under the Agreement and for the other contractors and the Owner's Personnel.
- 3.3.4 Disputes and other matters in question between the Contractor and other contractors shall be dealt with as provided in 12. DISPUTE RESOLUTION provided the other contractors have reciprocal obligations. The Contractor shall be deemed to have consented to arbitration of any dispute with any other contractor whose contract with the Owner contains a similar agreement to arbitrate.
- 3.3.5 Notwithstanding that the Owner may award separate contracts in connection with other parts of the Project to other contractors and perform work with its Personnel, the performance of such work or connection of such work onto the Work, by the Owner's Personnel or by other contractors, will not limit or relieve the Contractor of its obligations and responsibilities under the Agreement (including warranty) unless a Deficiency has been created by the Owner's Personnel or Owner's other contractors.
- 3.3.6 When requested in writing by the Contract Administrator or Owner, the Contractor shall stop Work on the Project so as to avoid interference with work being performed at adjacent or impacted construction projects of the Owner that are unrelated to the Project. The Contractor shall not be entitled to an extension of the Contract Time or to an increase in the Contract Price unless, and only to the extent, the event which caused the cessation of the Work would entitle the Contractor to an extension of the

Construction Agreement

Schedule D – General Conditions

Contract Time or the reimbursement of the Contractor's Losses as provided in GC 7.5.1, 7.5.2 or 7.5.3.

3.4 TEMPORARY WORK

3.4.1 The Contractor shall have the sole responsibility for the design, erection, operation, maintenance, removal and repair of Temporary Work.

3.4.2 The Contractor shall engage and pay for registered professional engineering Personnel skilled in the appropriate disciplines to perform those functions referred to in GC 3.4.1 where required by Laws or by the Agreement and in all cases where such Temporary Work is of such a nature that professional engineering skill is required or prudent to produce safe and satisfactory results.

3.4.3 Notwithstanding the provisions of 3.1 - CONTROL OF THE WORK, GC 3.4.1 and 3.4.2 or provisions to the contrary elsewhere in the Agreement, but subject to 3.6 – DOCUMENT REVIEW, where the Agreement includes designs for Temporary Work:

- .1 such designs shall be considered to be part of the design of the Work and the Contractor shall not be held responsible for that part of the design; and
- .2 the Contractor shall, however, be responsible for the execution of such design in the same manner as for the execution of the Work.

3.4.4 2.3 - REVIEW AND INSPECTION OF THE WORK and the requirements for Shop Drawings in 3.11 – SHOP DRAWINGS also apply to the Temporary Work.

3.5 CONSTRUCTION SCHEDULE

3.5.1 The Contractor shall:

- .1 prepare and submit to the Owner and the Contract Administrator within seven (7) Calendar Days from the Commencement Date, unless otherwise stipulated elsewhere in the Agreement or agreed to by the Contract Administrator, a construction schedule for their review and acceptance that indicates the timing of the major activities of the Work and provides sufficient detail of the critical events and their inter-relationship to demonstrate the Work shall be performed in conformity with the Contract Time. The construction schedule shall:
 - (1) take into account the phasing and sequencing of construction and the completion dates contained in the Agreement or as otherwise required by the Contract Administrator or the Owner;
 - (2) include and conform to the Key Work Milestones or any other milestones for the performance of the Work set out in the Agreement;
 - (3) be of a computerised type and provided in both electronic format and hard copy;

Construction Agreement

Schedule D – General Conditions

- (4) show the Project critical path and the critical path must be identified in a contrasting colour (red) from the other activities;
- (5) clearly show, in weekly intervals, the logic and timing of major activities, proposed start dates and estimated duration for activities; and
- (6) have a level of detail sufficient to identify the Contractor and each specific Subcontractor and their respective parts of the Work and the specific location thereof.

Once approved by the Owner and the Contract Administrator, the construction schedule submitted by the Contractor under this GC 3.5.1.1, as updated by the Contractor and approved by the Owner and Contract Administrator, shall become the “**Construction Schedule**”. The Construction Schedule (and any approved updates) shall be the benchmark against which the progress of the Work is to be measured for the purposes of the Agreement;

- .2 monitor the progress of the Work relative to the Construction Schedule;
- .3 maintain a Current Schedule and update the Current Schedule every two (2) weeks, unless otherwise stipulated elsewhere in the Agreement or agreed to by the Contract Administrator, and provide the updated Current Schedule to the Owner and Contract Administrator. For clarity, the Current Schedule shall be used for information purposes only;
- .4 advise the Contract Administrator of any revisions required to the Construction Schedule as the result of extensions of the Contract Time as provided in 7.CHANGES IN THE WORK and provide the Owner and Contract Administrator for approval, an updated Construction Schedule reflecting such extensions; and
- .5 perform the Work in accordance with the Construction Schedule including the Key Work Milestones.

3.5.2 If the Contractor fails to submit the initial or any updated Construction Schedule satisfactory to the Contract Administrator, the Owner shall be entitled to withhold or delay payments under the Agreement until the Contractor complies with the requirements of GC 3.5.1.

3.6 DOCUMENT REVIEW AND EXAMINATION OF SITE

3.6.1 The Contractor shall review the Agreement in accordance with the Standard of Care. The Contractor shall report to the Contract Administrator, no later than three (3) Working Days after discovery by the Contractor, any error, inconsistency or omission the Contractor may discover. The Contractor shall not be liable for Losses resulting from errors, inconsistencies or omissions in the Agreement, which the Contractor did not discover, provided that the Contractor exercised such Standard of Care. The Contractor shall be liable and responsible for Losses (and without any extension of the Contract Time) resulting from errors, inconsistencies or omissions in the Agreement if it recognizes, or should have recognized, exercising such Standard of Care, such errors, inconsistencies or omissions, yet fails to raise such errors,

Construction Agreement

Schedule D – General Conditions

inconsistencies or omissions to the Contract Administrator's attention prior to performing the affected portion of the Work.

- 3.6.2 If the Contractor does discover any error, inconsistency or omission in the Agreement or has any doubt as to the meaning or intent of any part thereof, the Contractor shall not proceed with the Work affected until the Contractor has reported to the Contract Administrator and received corrected or missing information, instructions or explanations from the Contract Administrator in writing. The Contractor shall comply with such information, instructions or explanations. The Contractor shall cooperate in good faith with the Owner and the Contract Administrator to resolve any error, omission or inconsistency in the Agreement in a manner that will not result in increased cost to the Owner or any extension of the Contract Time.
- 3.6.3 The Owner makes no representation, warranty or guarantee about the accuracy, completeness, feasibility or any other aspect of the documents or information provided by the Owner including interpretations of data or opinions expressed in any subsurface report or geotechnical report. Accordingly, the Contractor shall review and otherwise deal with such documents or information in accordance with the requirements of GC 3.6.1 and 3.6.2.
- 3.6.4 Without limitation to any specific obligations in the Drawings and Specifications in respect of the examination of the Site and surrounding area, the Contractor represents and warrants that in entering into the Agreement with the Owner and acting in accordance with the Standard of Care, it has examined the Site and surrounding area and it has satisfied itself as to the scope and character of the Work, all conditions and information affecting the Work, including the nature of the Work and the Site, access to the Site and weather conditions or that, not having acted in such a manner, the Contractor has assumed and does hereby assume all risk of conditions now existing or arising in the course of the Work which might or could make the Work more expensive or more onerous to fulfil and which a contractor acting in accordance with the Standard of Care would have discovered. The cost and time of all conditions referred to in this GC 3.6.4 form part of the Fixed Price and Unit Prices and the Contract Time and shall not be the basis for an increase in the Fixed Price or Unit Prices or any extension of the Contract Time.

3.7 SUPERVISION

- 3.7.1 The Contractor shall provide all necessary supervision.
- 3.7.2 The Contractor shall:
- .1 furnish competent and adequate Personnel, who shall be in attendance at the Site at all times, as necessary, for the proper administration, co-ordination, supervision and superintendence of the Work;
 - .2 organize the procurement of all Products and Construction Equipment so that they will be available in advance of the time they are needed for the Work; and
 - .3 keep an adequate force of skilled Personnel on the job to complete the Work in accordance with all requirements of the Agreement.

Construction Agreement

Schedule D – General Conditions

- 3.7.3 Prior to commencement of the Work, unless otherwise stipulated elsewhere in the Agreement or agreed to by the Contract Administrator, the Contractor shall select a competent and experienced:
- .1 Project manager (the “**Contractor Project Manager**”) who shall:
 - (1) be in attendance at the Site or otherwise engaged in the Work at all times, or for such other period of attendance as required by the Agreement including the Specifications;
 - (2) have full responsibility for the prosecution of the Work, with full authority to act in all matters as may be necessary for the proper co-ordination, supervision, direction and technical administration of the Work;
 - (3) attend site meetings in order to render reports on the progress of the Work; and
 - (4) have authority to bind the Contractor in all matters related to the Agreement; and
 - .2 supervisor of the Site (the “**Contractor Site Supervisor**”) who shall be in attendance at the Site at all times while Work is being performed, or for such other period of attendance as required by the Agreement including the Specifications and shall have full responsibility for the day to day field supervision and superintendence of the Work.
- 3.7.4 The Contractor Project Manager and the Contractor Site Supervisor, if applicable:
- .1 shall represent the Contractor at the Site; and
 - .2 may be the same individual if specified as such in the Specifications.
- 3.7.5 Information, notices and instructions given to the Contractor Project Manager and/or the Contractor Site Supervisor, if applicable, shall be deemed to have been received by the Contractor, other than notices that are required to be delivered in accordance with 1.6 - RECEIPT OF AND ADDRESSES FOR NOTICES AND DOCUMENTATION.
- 3.7.6 At the request of the Owner, the Contractor shall supply complete information including written job-specific qualification records for any Personnel of the Contractor, Subcontractors, Suppliers or Sub-subcontractors. Such records will detail the activities that each such Personnel has been trained and qualified to perform.
- 3.7.7 If the Owner observes that any Personnel of the Contractor, Subcontractors, suppliers or Sub-subcontractors is potentially incompetent, disorderly or a detriment to the Project, then the Owner shall provide Notice in Writing to the Contractor and the Contractor, at the Contractor's cost and without any extension of the Contract Time, shall, in accordance with its obligations under the Agreement, immediately remove such Personnel from the Site if the Contractor determines that such Personnel should be immediately removed from the Site. If such Personnel is

Construction Agreement

Schedule D – General Conditions

removed, the Contractor, at the Contractor's cost and without any extension of the Contract Time, shall provide replacement Personnel acceptable to the Owner. Such incompetent, disorderly or detrimental Personnel shall not return to the Site without the prior written consent of the Owner or Contract Administrator.

3.7.8 Without limiting the obligations of the Contractor described in 3.3 – CONSTRUCTION BY OWNER OR OTHER CONTRACTORS and 4.2 – HEALTH AND SAFETY, if the Owner or Contract Administrator observes that any Personnel of the Contractor, Subcontractors, Suppliers or Sub-subcontractors poses an imminent risk to the health and safety of other persons, then the Owner or Contract Administrator can require the Contractor to immediately remove such Personnel from the Site at the Contractor's cost and without any extension of the Contract Time, and in accordance with its obligations under the Agreement. The Contractor, at the Contractor's cost and without any extension of the Contract Time, shall provide replacement Personnel acceptable to the Owner. The Personnel that posed an imminent risk to the health and safety of other persons shall not return to the Site without the prior written consent of the Owner or Contract Administrator.

3.7.9 The Contractor shall provide the Owner and the Contract Administrator with the names, work addresses and mobile telephone numbers of the Contractor Project Manager, the Contractor Site Supervisor and other responsible field Personnel who may be contacted for emergency and other reasons during non-working hours and update as necessary.

3.8 SUBCONTRACTORS AND SUPPLIERS

3.8.1 The Contractor may, subject to this 3.8 – SUBCONTRACTORS AND SUPPLIERS, subcontract portions of the Work, which shall not exceed the portion set out in row E.2 of the Information Sheet, to Subcontractors and Suppliers. The Contractor shall, and shall cause the Subcontractors, Suppliers and Sub-subcontractors to, perform the Work in accordance with the Agreement. The Contractor shall be fully responsible to the Owner for the Subcontractors', Suppliers' and Sub-subcontractors' failure to abide by the obligations of the Agreement.

3.8.2 The Contractor shall preserve and protect the rights of the parties under the Agreement with respect to the portion of the Work to be performed under subcontract, and shall:

- .1 enter into subcontracts with Subcontractors and Suppliers to require them to perform their portion of the Work as provided in the Agreement;
- .2 provide the Owner or Contract Administrator with a redacted copy of any subcontract with a Subcontractor or Supplier, and all applicable amendments and changes, promptly upon request of the Owner, and in no event later than within five (5) Working Days of such request.
- .3 incorporate, or cause to be incorporated, into all subcontracts with Subcontractors and Suppliers the terms and conditions of the Agreement, including:

Construction Agreement
Schedule D – General Conditions

- (1) the contract number set out on the cover page of the Agreement and Project description set out in row A.1 of the Information Sheet;
 - (2) 9.3 – WARRANTY, GC 13.2.4 and Schedule F - Owner Policies, Procedures, By-Laws and Other Requirements;
 - (3) a provision requiring the Subcontractor or Supplier to provide adequate notice to the Contractor in order for the Contractor to fulfill its obligations under GC 12.2.16. For clarity, such provision shall include a requirement that the Subcontractor or Supplier include a similar provision in all its subcontracts with Sub-subcontractors and all such Sub-subcontractors to include a similar provision in all their subcontracts with their Sub-subcontractors and so on within every tier of the construction pyramid; and
 - (4) a provision that permits the Contractor's interest in the subcontract to be immediately assigned, at the same price and in the Owner's sole and absolute discretion, to the Owner or the Owner's designee upon Notice in Writing thereof given by the Owner to both Contractor and Subcontractor or Supplier, as the case may be, for nominal consideration of \$5.00, provided, however, that until the Owner has given such Notice in Writing, nothing herein contained shall be deemed to create any contractual or other liability upon the Owner for the performance of obligations under such subcontracts and the Contractor shall be fully responsible and liable for all of its obligations and liabilities (if any) under such subcontracts; and
- .4 have control over, charge of, and be fully responsible to the Owner for, the acts and omissions of Subcontractors, Suppliers and their Personnel and for the acts and omissions of Personnel of the Contractor even if such Subcontractor or Supplier was approved or selected by the Owner.
- 3.8.3 Unless expressly stated otherwise in row A.6 of the Information Sheet, the Contractor may only use the Subcontractors and Suppliers identified in row A.6 of the Information Sheet for the specific portion of the Work which they are identified as performing for the Project. Contractor shall not:
- .1 change any of such identified Subcontractors or Supplier or let any subcontracts for the performance of the Work to Subcontractors and Suppliers that have not been identified in row A.6 of the Information Sheet;
 - .2 use a Subcontractor or Supplier to perform Work which has not been identified in row A.6 of the Information Sheet as being performed by such Subcontractor or Supplier,
- without the prior written approval of the Owner. The Owner shall be entitled to a minimum of ten (10) Working Days to review and approve any such request for approval by the Contractor. Without limiting the generality of the factors or criteria which the Owner and Contract Administrator may consider during such review and approval process, the Owner shall be entitled to consider the proposed Subcontractor's or Supplier's compliance with the Owner's Policies, Procedures and By-laws. Any approved replacement of a Subcontractor or Supplier shall be made

Construction Agreement

Schedule D – General Conditions

with no increase in the Contract Price and extension of the Contract Time and any costs incurred by the Owner for the services of the Contract Administrator in reviewing such proposed replacement shall be borne by the Contractor.

3.8.4 The Owner's consent to subcontracting by the Contractor shall not be construed as relieving the Contractor from any obligation under the Agreement and shall not impose any liability on the Owner.

3.8.5 The Owner, through the Contract Administrator, may provide to a Subcontractor, Supplier and Sub-subcontractor information as to the percentage of the Subcontractor's or Supplier's Work which has been certified for payment.

3.8.6 The Contractor shall pay the Subcontractors and Suppliers on a timely basis in accordance with the terms of their respective subcontracts and applicable Laws.

3.9 LABOUR AND PRODUCTS

3.9.1 The Contractor shall provide and pay for labour, Products, Construction Equipment, water, heat, light, power, transportation, and other facilities and services necessary for the performance of the Work in accordance with the Agreement. Without limiting the generality of the foregoing, the Contractor shall pay its Personnel, and shall cause the Subcontractors and Suppliers to pay their Personnel, performing the Work, in accordance with the labour related provisions set out in the Agreement and at intervals no less than those required by such Personnel's employment or labour agreements.

3.9.2 The Contractor covenants and agrees that the Work, including all Products and components thereof, shall conform to the Agreement in all respects, and, unless otherwise specified in the Agreement, shall be of merchantable quality and fit for their intended purpose as described in the Contract Documents and shall be new and free from Deficiencies. Products which are not specified shall be of a quality consistent with those specified and the use of such Products shall be subject to the acceptance of the Contract Administrator or Owner. This GC 3.9.2 shall be in addition to and not in limitation of any other right or remedy granted by the Agreement or otherwise available to the Owner.

3.9.3 Title to the Work including the Products (and each portion thereof) shall pass to the Owner immediately upon payment therefore (subject to applicable holdback that is not then due) or upon incorporation of the Products into the Work at the Site, whichever first occurs, free and clear of all liens, charges and encumbrances (subject to any rights or remedies provided by the Construction Act, if applicable). Notwithstanding any transfer of title to the Work or any portion thereof to the Owner, the Contractor shall be responsible for and bear the risk of Loss with respect to the Work (including Products delivered to the Site, whether or not incorporated into the Work) until the date of Total Performance of the Work. Title to Owner Supplied Material shall remain with the Owner at all times.

Construction Agreement

Schedule D – General Conditions

3.9.4 Substitutions

- .1 The Contractor shall not substitute any Product without the prior written approval of the Contract Administrator and the Owner.
- .2 Where the Agreement requires the Contractor to supply a Product, the Contractor may apply to the Contract Administrator to propose a substitution for such Product (“**Substitution**”) that equals or exceeds the quality, suitability, reliability, durability and performance of the Product designated in the Agreement. The application by the Contractor to the Contract Administrator for a Substitution shall be:
 - (1) in writing and include complete data as to the quality, suitability, reliability, durability, performance and projected cost or cost savings of the Substitution, impact on the Construction Schedule and such other information as the Contract Administrator may require; and
 - (2) made in such time as to ensure that the review and approval process by the Contract Administrator and the Owner shall not adversely impact the Construction Schedule.

The burden of proving the quality, suitability, reliability, durability and performance of a Substitution shall be upon the Contractor.

- .3 The approval or rejection of a Substitution shall be made at the sole and absolute discretion of the Contract Administrator and the Owner. Notwithstanding the foregoing, the Contractor shall not be entitled to any increase in Contract Price or extension of the Contract Time as a result of the review, approval or rejection of a Substitution by the Contract Administrator or the Owner.
- .4 Approval of a Substitution will only be for the specific circumstances set out in the application and shall not change or modify any other requirement contained in the Agreement or establish approval for the Substitution to be used in any other portion of the Work that is unrelated to the subject approval.

3.9.5 All surplus Products which have not been used in the performance of the Work shall be removed from the Site when notified in writing to do so by the Contract Administrator. The cost for such surplus Products shall be credited to the Fixed Price or Total Price of Unit Price Work under the Proper Invoice submitted pursuant to GC 5.7.1.1, to the extent the Owner has paid for such surplus Products.

3.9.6 The cost of overtime Work (including overtime rates):

- .1 required beyond the normal working day at the Site (as may be described in the Specifications) to complete individual construction operations of a continuous nature in respect of Fixed Price Work or Unit Price Work, such as pouring or finishing of concrete or similar Work; or

Construction Agreement

Schedule D – General Conditions

- .2 in respect of Fixed Price Work or Unit Price Work that the Contractor elects to perform without the Owner or the Contract Administrator requesting such overtime Work; or
- .3 except as expressly provided for in the Specifications as a part of the Contract Price,

shall not be chargeable to the Owner and shall be at the cost of the Contractor and without adjustment in the Fixed Price or Unit Prices.

- 3.9.7 The Contractor shall maintain good order and discipline among the Contractor Parties engaged on the Work and shall not employ on the Work anyone not skilled in the tasks assigned.

3.10 DOCUMENTS AT THE SITE

- 3.10.1 The Contractor shall control, store and retain copies (one of which must be in hardcopy) of the Agreement, Submittals, reports, and records of meetings at the Site, in good order and readily available to the Owner and the Contract Administrator. Upon the request of the Owner, the Contractor shall provide hard copies and electronic copies of all the foregoing documents to the Owner, at the Owner's cost, except to the extent the delivery of such document already forms part of the Fixed Price Work.

- 3.10.2 The Contractor shall accurately and continuously note on the Drawings and Specifications kept by the Contractor at the Site, (1) all approved changes and deviations made during the Work which differ from that shown or specified in the Agreement and reviewed Shop Drawings indicating, in a neat, accurate and legible manner the Work as actually installed; (2) the exact location and detail of buried, embedded or concealed as-built conditions and all other as-built conditions of the Work (including the location of all asbestos abatement Work dealing with such matters as floor tiles and pipe insulation); and (3) the exact location and detail of Work installed on a "field run" basis (collectively, the "**As-Built Drawings**"). If any Work is performed otherwise than as shown in the Agreement, the Contractor shall note on such As-Built Drawings the Work as installed, including with respect to the mechanical, electrical and fire protection Work. The As-Built Drawings shall be made available for review by the Owner and the Contract Administrator at all times. The Contractor shall deliver the As-Built Drawings to the Owner on or before Substantial Performance of the Work, in the following format: (A) one complete set of reproducible final versions; and (B) one complete set stored on the latest edition of AutoCAD or such other format required by the Owner.

3.11 SHOP DRAWINGS

- 3.11.1 The Contractor shall provide Shop Drawings if required by the Agreement or as the Contract Administrator may reasonably request. The Shop Drawings shall meet the requirements of the Agreement (including this 3.11, unless otherwise stipulated elsewhere in the Agreement or agreed to by the Contract Administrator) and the Contractor shall carry out the Work in accordance with Shop Drawings which meet such requirements. The Contractor shall not perform any portion of the Work covered

Construction Agreement

Schedule D – General Conditions

- by or affected by Shop Drawings until the Contract Administrator has completed its review of such Shop Drawings for construction in accordance with the procedure referred to in the Agreement.
- 3.11.2 The Contractor shall provide Shop Drawings to the Contract Administrator to review in orderly sequence and sufficiently in advance so as to cause no delay in the Work or in the work of other contractors.
- 3.11.3 Upon request of the Contractor or the Contract Administrator, they shall jointly prepare a schedule of the dates for provision, review and return of Shop Drawings.
- 3.11.4 The Contractor shall provide Shop Drawings in the form specified, or if not specified, as directed by the Contract Administrator.
- 3.11.5 Shop Drawings provided by the Contractor to the Contract Administrator shall indicate by stamp, date and signature of the Person responsible for the review that the Contractor has reviewed each one of them.
- 3.11.6 The Contract Administrator's review is for conformity to the design concept and for general arrangement only and shall not relieve the Contractor of responsibility for errors or omissions in the Shop Drawings or for meeting all requirements of the Agreement.
- 3.11.7 Shop Drawings which require approval of any legally constituted authority having jurisdiction shall be provided to such authority by the Contractor for approval.
- 3.11.8 The Contractor shall review all Shop Drawings before providing them to the Contract Administrator. The Contractor represents by this review that:
- .1 the Contractor has determined and verified all applicable field measurements, field construction conditions, Product and Owner Supplied Material requirements, catalogue numbers and similar data, or will do so, and
 - .2 the Contractor has checked and co-ordinated each Shop Drawing with the requirements of the Work and of the Agreement.
- 3.11.9 At the time of providing Shop Drawings, the Contractor shall expressly advise the Contract Administrator in writing of any deviations in a Shop Drawing from the requirements of the Agreement. The Contract Administrator shall indicate the acceptance or rejection of such deviation expressly in writing.
- 3.11.10 The Contractor shall provide revised Shop Drawings to correct those which the Contract Administrator rejects as inconsistent with the Agreement, unless otherwise directed by the Contract Administrator. The Contractor shall notify the Contract Administrator in writing of any revisions to the Shop Drawings other than those requested by the Contract Administrator.
- 3.11.11 The Contract Administrator shall review and return Shop Drawings in accordance with the schedule agreed upon, or, in the absence of such schedule, with reasonable promptness so as to cause no delay in the performance of the Work.

Construction Agreement

Schedule D – General Conditions

3.11.12 The Contractor shall provide the Owner with a "specification compliance report" from the manufacture or Supplier of each item of equipment forming part of the Products. The specification compliance report shall provide details which demonstrate that all applicable requirements of the Drawings and Specifications have been satisfied. Any deviations from such requirements must be addressed in the specification compliance report to the satisfaction of the Owner, as confirmed by the Owner. For clarity, any deviation set out in the specification compliance report is not accepted by the Owner, except to the extent such acceptance has been confirmed in writing by the Owner.

3.12 USE OF THE WORK

3.12.1 The Contractor shall confine Construction Equipment, Temporary Work, storage of Products, Owner Supplied Material, waste products and debris, and operations of Contractor Parties to limits indicated by Laws or the Agreement and shall not unreasonably encumber the Site. All Products and Owner Supplied Equipment shall be stored under suitable conditions to prevent damage, deterioration, and contamination.

3.12.2 The Contractor shall not load or permit to be loaded any part of the Work or any part of the Site with a weight or force that shall or could be considered to endanger the safety or integrity of the Work or any part of the Site, individuals and the area adjacent to the Site.

3.13 STANDARD OF CARE, QUALITY ASSURANCE AND QUALITY CONTROL

3.13.1 In performing the Work, the Contractor shall exercise a standard of care, skill and diligence that would normally be provided by an experienced, qualified and prudent contractor supplying similar work for similar projects ("**Standard of Care**"). The Contractor acknowledges and agrees that throughout the term of the Agreement, the Contractor's obligations, duties and responsibilities shall be interpreted in accordance with the Standard of Care. The Contractor shall exercise the Standard of Care in respect of any Products and Personnel which it may recommend to the Owner.

3.13.2 If required by the Specifications, the Contractor shall develop and maintain a quality assurance and quality control plan ("**QA/QC Plan**"), in accordance with the Specifications, to ensure that the Work, including the performance of the Work is in accordance with the Agreement.

3.13.3 As of the Effective Date, the Contractor represents and warrants that there are no pending, threatened or anticipated Claims that would have a material effect on the financial ability of the Contractor to perform the Work. The Contractor shall immediately notify the Owner of any such Claims that arise after the Effective Date and shall take all necessary and prudent steps to remedy or resolve such Claims to ensure that the performance of the Work is unaffected.

3.14 USE AND OCCUPANCY OF THE WORK PRIOR TO SUBSTANTIAL PERFORMANCE OF THE WORK

3.14.1 Without limitation to any other right of the Owner in the Agreement, the Owner shall, at any and all times, have the right to enter, occupy and use the Work or any part

Construction Agreement
Schedule D – General Conditions

thereof prior to Substantial Performance of the Work if such entry and occupancy does not materially interfere with the Contractor's performance and the completion of the Work within the Contract Time. Should the Owner wish to use or occupy part or all of the Work prior to Substantial Performance of the Work, the Owner shall give thirty (30) Calendar Days' Notice in Writing to the Contractor of the intended purpose and extent of such use or occupancy.

3.14.2 If the Owner exercises the right of occupancy and/or use of the Work in accordance with GC 3.14.1, it agrees to do so in a manner that does not materially interfere with the Contractor's performance and the completion of the Work within the Contract Time and with the understanding that the Owner will be occupying premises within a construction site which will require compliance with all normal construction site requirements including health and safety requirements.

3.14.3 The use or occupancy of the Work or any part thereof by the Owner prior to Substantial Performance of the Work shall not constitute an acceptance of the Work or parts so occupied. Such use or occupancy of the Work shall not:

- .1 relieve or limit the Contractor or its surety from any responsibilities under the Agreement or liability that has arisen, or may arise, from the performance of the Work;
- .2 waive the Owner's right to charge the Contractor liquidated damages (including Delay Liquidated Damages) in accordance with the terms of the Agreement; or
- .3 affect the Warranty Period or the warranties set out in the Agreement.

3.14.4 Within five (5) Working Days of receiving the Notice in Writing referred to in GC 3.14.1, the Contractor shall notify the Owner in writing of the additional premium cost, if any, to maintain all risk property insurance coverage (including boiler coverage). The cost of such additional premium shall be paid by the Owner (but without any markup by the Contractor) through the issuance of a Change Order, provided that the Owner's need to use or occupy the space did not arise as a result of the Work being behind schedule for a reason other than as described in GC 7.5.1 , 7.5.2 or 7.5.3. If because of such use or occupancy the Contractor is unable to provide such additional coverage, the Owner shall provide, maintain and pay for all risk property insurance coverage (including boiler coverage) insuring the full value of the used or occupied portion of the Work, including coverage for such use or occupancy, and shall provide the Contractor with proof of such insurance. The Contractor shall refund to the Owner the unearned premiums applicable to the Contractor's policies upon termination of coverage.

3.15 ACCESS TO PROPERTIES ADJOINING THE WORK AND INTERRUPTION OF OPERATIONS

3.15.1 The Contractor shall provide, at all times and at no extra cost to the Owner and without extension of the Contract Time, access to fire hydrants, water and gas valves, and all other Utilities and Structures and access to any existing equipment located at the Site which remains in operation by the Owner over the duration of the Project.

Construction Agreement

Schedule D – General Conditions

The operation of any such Utilities and Structures and equipment shall take precedence over the Work in the case of conflicts.

- 3.15.2 The Contractor acknowledges that during the term of the Contract, the Place of the Work and the area in the vicinity of the Place of the Work may be occupied by the Owner and other Persons and that, if so occupied, such Persons will continue to carry out their normal operation and use of Place of the Work and shall be allowed to maintain their services and business continuity. The Contractor shall perform the Work in the least intrusive manner possible so as to avoid interfering with any such operations in the vicinity of the Work. The Contractor shall not disrupt the use or enjoyment of the Place of the Work and the vicinity by the Owner and other Persons.

4. PROTECTION OF PERSONS, WORK AND PROPERTY

4.1 PROTECTION OF WORK AND PROPERTY

- 4.1.1 The Contractor shall protect the Work, Persons and the Owner's property and property adjacent to, in the vicinity of or proximate to the Site from damage which may arise as the result of the Work (including from settlement of ground, flow of water, vibration or shock), and the Contractor shall, and shall cause the other Contractor Parties to, take all precautions to avoid such damage. The Contractor shall be responsible for making good any such damage, at its cost, except damage which occurs as the result of:
- .1 subject to 3.6 – DOCUMENT REVIEW, errors, inconsistencies or omissions in the Agreement; and
 - .2 negligent acts or omissions by the Owner, the Owner Representative, the Contract Administrator, any other contractors (other than the Contractor Parties), and their respective Personnel.
- 4.1.2 Should damage occur to the Work or Owner's property for which the Contractor is not responsible for pursuant to the Agreement, the Contractor shall make good such damage to the Work and, if the Owner so directs, to the Owner's property. The Contract Price and Contract Time shall be adjusted as provided in 7.1 - OWNER'S RIGHT TO MAKE CHANGES, 7.2 - CHANGE ORDER and 7.3 - CHANGE DIRECTIVE.
- 4.1.3 Construction Affecting Railway Property or Third Party Operations
- .1 The Contractor shall be required to conduct the Work in such a manner as to avoid the possibility of damaging or interfering with any railway property in the vicinity of the Work. Every reasonable precaution shall be taken by the Contractor to ensure the safety and protection of all Contractor Parties and Construction Equipment and railway property (at track crossings or otherwise) and users thereof throughout the performance of the Work.
 - .2 The Owner shall pay the costs of all flagging and other traffic control measures required and provided by a railway company unless such costs are solely a function of the Contractor's chosen method of completing the Work.

Construction Agreement

Schedule D – General Conditions

4.1.4 Operational Risk

- .1 The position of all pole lines, conduits, pipes, watermains, sewers and other covered, underground and overground utilities and structures in, on, adjacent to under or over the Site (collectively, the “**Utilities and Structures**”) are not necessarily provided in the Agreement, and where provided, the accuracy of the position of such Utilities and Structures is not guaranteed and the Owner disclaims all liability with respect to same except to the extent explicitly stated otherwise in row E.3 of the Information Sheet. The Contractor shall be liable for damages to the Utilities and Structures as a result of any act or omission, whether or not the result of negligence, by the Contractor Parties and the Losses relating to such damage shall not be chargeable to the Owner and shall be at the cost of the Contractor.
- .2 Without limiting the generality of GC 4.1.4.1, before commencing any Work, the Contractor shall inform itself of the existence and exact condition, size, depth and location of all Utilities and Structures in accordance with the Standard of Care and the Specifications, if applicable, and such process shall occur in conjunction with the Contractor’s review of the Agreement pursuant to GC 3.6.1. For clarity, to the extent the Owner is required to provide such information to the Contractor as a part of its obligation under Laws, including the *Ontario Underground Infrastructure Notification System Act, 2012*, any work required to obtain such information shall be performed by the Contractor as a part of the Work without any increase to the Contract Price or extension of the Contract Time.
- .3 As a part of, and in co-ordination with, the Work, the Contractor shall provide for the removal, protection, support, temporary and permanent relocation and restoration of the Utilities and Structures to the satisfaction of the owners of the Utilities and Structures, and in performing such Work, the Contractor shall comply with the requirements of the owners of the Utilities and Structures. The Contractor shall arrange with the appropriate owners for the stake out of all Utility and Structure connections that may be affected by the Work. The Contractor shall maintain records of such stake outs and make such records available to the Owner upon request. The Contractor shall observe the location of such stake outs, prior to commencing the Work, and in the event that there is a discrepancy between the location of such stake outs and the locations provided in the Agreement, that may affect the Work, the Contractor shall, prior to performing the affected portion of the Work, immediately notify the Contract Administrator and the affected owners of the Utilities and Structures, in order to resolve the discrepancy.
- .4 Where any interruptions in the supply of utility services are required and are authorized by the Contract Administrator, the Contractor shall, in consultation with the Owner, give the affected property owners notice in accordance with the Specifications, and shall arrange such interruptions so as to create a minimum of interference to those affected.

4.1.5 Without in any way limiting the Contractor’s obligations under 4.1, should the Contractor or any Subcontractor, Supplier or Sub-subcontractor cause Losses to trees or other plantings, whether owned by the Owner or third parties, the Contractor

Construction Agreement

Schedule D – General Conditions

shall be liable for the replacement cost of the trees or other plantings damaged, including the cost of any arborist or other consultant, and such Losses may be set-off in accordance with 5.10 – OWNER’S SET-OFF.

- 4.1.6 The Contractor shall immediately inform the Contract Administrator of all damage that occurs during the term of the Agreement. The Contractor shall then investigate and report back to the Contract Administrator and Owner within fifteen (15) Calendar Days of the occurrence of such damage. Such reports shall include all details as the Owner and Contract Administrator require. The Contractor shall neither undertake to repair and/or replace any damage whatsoever to the Work of other contractors, or to adjoining property, nor acknowledge the same was caused or occasioned by the Contractor, without first consulting the Owner and receiving written instructions as to the course of action to be followed from either the Owner or the Contract Administrator. However, where there is imminent danger to life or public safety, the Contractor shall take such emergency action as it deems necessary to remove the danger. The Contractor shall notify the Owner of such imminent danger as promptly as is practicable under the circumstances. The Contract Administrator may conduct its own investigation and the Contractor shall provide all assistance to the Contract Administrator and Owner as may be necessary for that purpose.
- 4.1.7 The Contractor shall immediately upon becoming aware of a complaint or Claim made by a resident or property owner, inform the Contract Administrator and the Owner.

4.2 HEALTH AND SAFETY

4.2.1 The Contractor shall, until Total Performance of the Work, be solely responsible for:

- .1 construction health and safety at the Site;
- .2 compliance with the Laws and practices which relate to construction health and safety, including OHSA; and
- .3 initiating, maintaining, and supervising all safety precautions and programs in connection with the performance of the Work and the other work performed by the Owner’s Personnel and other contractors at the Site (collectively, the “**Other Work**”).

4.2.2 Without restricting the generality of any other provision in the Agreement, the Contractor shall, for the purposes of the OHSA, be deemed, construed and designated as the "constructor" for the Work (including the Work of the Subcontractors, Suppliers and Sub-subcontractors and the Other Work of the Owner’s Personnel and other contractors at the Site) and shall assume and fulfill all of the responsibilities of constructor as set out in OHSA in respect of the Work and the Other Work and the Site from the Commencement Date until Total Performance of the Work. Unless explicitly stated otherwise in the Agreement, nothing in the Agreement shall be deemed or construed as making the Owner the “employer” (as defined in OHSA) or the "constructor" (as defined in OHSA), either instead of or jointly with the Contractor.

Construction Agreement

Schedule D – General Conditions

- 4.2.3 The Contractor shall establish and administer a health and safety plan for the performance of the Work at the Site, which shall comply with the requirements of all Governmental Authorities having jurisdiction and all Laws. The Contractor shall provide the Owner with a copy of the health and safety plan prior to the Commencement Date. The Contractor shall ensure the Contractor Parties, Owner's Personnel and other contractors at the Site comply with the health and safety plan. As part of its reporting obligations on the progress of the Work described in the Specifications, the Contractor shall provide information on the ongoing implementation of its health and safety plan.
- 4.2.4 Prior to the Commencement Date, the Contractor shall submit to the Owner:
- .1 a current WSIB clearance certificate;
 - .2 a tax statutory declaration in the form attached as Form 3 of Schedule G – Forms;
 - .3 documentation of the Contractor's in-house corporate level health and safety program;
 - .4 a copy of the Notice of Project filed with the Ministry of Labour naming itself as "constructor" under OHSA; and
- 4.2.5 The Contractor shall possess and maintain a valid Certificate of Recognition (COR™) or an Equivalent OHS Certification for the duration of performance of the Agreement. The Contractor shall provide the Contract Administrator with a new Certificate of Recognition (COR™) or Equivalent OHS Certification immediately upon the expiry of the previous Certificate of Recognition or Equivalent OHS Certification or otherwise upon demand by the Contract Administrator.
- 4.2.6 The Contractor shall report to the Owner all health and safety incidents at the Site including the Contractor's response. Without limiting the foregoing, the Contractor shall report any such incident occurring on or off the Site that relates to its Work or Other Work immediately, and shall, in addition, in no event later than forty-eight (48) hours give written notice of such incident
- 4.2.7 During the course of the Work, the Contractor shall furnish forthwith to the Contract Administrator a copy of all correspondence, reports, orders or charges respecting health and safety, including under OHSA, the *Technical Standards and Safety Act, 2000*, the *Highway Traffic Act*, the *Environmental Protection Act*, the *Workplace Safety and Insurance Act, 1997*, the *Employment Standards Act, 2000* and the *Criminal Code*, which are received by, or which come to the notice of, the Contractor that apply or are relevant to any of the Work or activities conducted under the terms of the Agreement. The Contractor shall immediately take all corrective measures necessary to address the issues identified or arising out of any such correspondence, report, order or charges.
- 4.2.8 Without limiting the obligations of the Contractor described in 3.3 – CONSTRUCTION BY OWNER OR OTHER CONTRACTORS and this 4.2 – HEALTH AND SAFETY, the Owner or Contract Administrator may, by written notice, direct the Contractor to

Construction Agreement
Schedule D – General Conditions

stop the Work where the Owner or Contract Administrator determines that there is an imminent risk to the safety of individuals or property at the Site. In the event that the Contractor receives such written notice, it shall immediately stop the Work and secure the Site. The Contractor shall not be entitled to an extension of the Contract Time or to an increase in the Contract Price unless, and only to the extent, the event which caused such imminent risk would entitle the Contractor to an extension of the Contract Time or the reimbursement of the Contractor's Losses as provided in GC 7.5.1, 7.5.2 or 7.5.3.

4.2.9 Nothing in the Agreement shall be construed as requiring the Contract Administrator or Owner to monitor or approve the health and safety practices of the Contractor.

4.3 HAZARDOUS MATERIALS

4.3.1 Unless expressly permitted in the Agreement, the Contractor shall, and shall cause the other Contractor Parties to, not bring onto the Site any Hazardous Materials without the prior written authorization of the Contract Administrator. No later than five (5) Working Days following execution of the Agreement and prior to the Contractor mobilizing to the Site, the Contractor shall provide to the Owner, a list of all Hazardous Materials, including safety data sheets, which the Contractor expects to use for the Work, for the Owner's review, and update the Owner with any changes made to the list. The Contractor shall also comply with all other provisions under OSHA related to Hazardous Materials.

4.3.2 The Contractor shall use all reasonable care to avoid spilling or disturbing any Hazardous Materials during the performance of the Work. In the case of a "spill" as defined in the *Environmental Protection Act*, the Contractor shall immediately notify the Owner and the Contract Administrator of the location and details of such spill and report the spill to the relevant Governmental Authority. Reporting a spill to the Owner shall not relieve the Contractor of its legislated responsibilities regarding spills or discharges.

4.3.3 If the Contractor or the Owner encounters Hazardous Materials at the Site or has reasonable grounds to believe that Hazardous Materials are present at the Site, which were not:

- .1 brought to the Site by the Contractor Parties;
- .2 disclosed by the Owner or in the Agreement; or
- .3 discovered by the Contractor through the fulfillment of its responsibilities pursuant to 3.6 - EXAMINATION OF SITE,

the Contractor shall:

- .4 take all necessary steps, in accordance with Laws, including stopping the Work, to
 - (1) manage, remove, dispose of, store or otherwise render harmless such Hazardous Materials;

Construction Agreement
Schedule D – General Conditions

- (2) ensure that no individual's exposure to any Hazardous Materials exceeds any applicable time weighted levels prescribed by Laws (including O Reg 833 under OHSA); and
- (3) ensure that no property is damaged or destroyed as a result of exposure to, or the presence of, such Hazardous Materials; and
- .5 immediately report the circumstances to the Contract Administrator and the other party in writing.

4.3.4 If the Owner and Contractor do not agree on:

- .1 the existence and significance of the Hazardous Materials described in GC 4.3.3;
- .2 if such Hazardous Materials were brought onto the Site by a Contractor Party;
- .3 if such Hazardous Materials were disclosed by the Owner or in the Agreement; or
- .4 if such Hazardous Materials should have been discovered by the Contractor through the fulfillment of its responsibilities pursuant to 3.6 - EXAMINATION OF SITE,

the Owner shall retain and pay for an independent qualified expert to investigate and determine such matters. The expert's report shall be delivered to the Owner and the Contractor.

4.3.5 If the Owner and Contractor agree or if the expert referred to in GC 4.3.4 determines that the Hazardous Materials were not brought onto the Site by a Contractor Party and were not disclosed by the Owner or in the Agreement and would not have been discovered by the Contractor through the fulfillment of its responsibilities pursuant to 3.6 - EXAMINATION OF SITE, the Owner shall immediately at the Owner's own cost:

- .1 reimburse the Contractor for the costs of all steps taken pursuant to GC 4.3.3; and
- .2 extend the Contract Time for such reasonable time as the Contract Administrator may recommend in consultation with the Contractor and the expert referred to in 4.3.4 and reimburse the Contractor for reasonable Losses incurred as a result of the delay, but excluding any consequential, indirect or special damages and loss of profit, loss of opportunity or loss of productivity resulting from such delay.

4.3.6 If the Owner and Contractor agree or if the expert referred to in GC 4.3.4 determines that the Hazardous Materials were brought onto the Site by a Contractor Party and were not disclosed by the Owner or in the Agreement and would not have been discovered by the Contractor through the fulfillment of its responsibilities pursuant to 3.6 - EXAMINATION OF SITE, the Contractor shall immediately at the Contractor's own cost and without extension of the Contract Time:

- .1 make good any damage to the Work, the Owner's property or property adjacent to the Site as provided in GC 4.1.1; and

Construction Agreement

Schedule D – General Conditions

- .2 reimburse the Owner for reasonable Losses incurred under GC 4.3.4 but excluding any consequential, indirect or special damages and loss of profit, loss of opportunity or loss of productivity.
- 4.3.7 If either party does not accept the expert's findings under GC 4.3.4, the disagreement shall be settled in accordance with 12. DISPUTE RESOLUTION. If such disagreement is not resolved within thirty (30) Calendar Days, the parties shall act immediately in accordance with the expert's determination and take the steps required by GC 4.3.5 or GC 4.3.6 it being understood that by so doing, neither party will jeopardize any claim that party may have to be reimbursed as provided by 4.3 - HAZARDOUS MATERIALS.
- 4.4 MOULD**
- 4.4.1 If the Contractor or Owner observes or reasonably suspects the presence of mould at the Site, the remediation of which is not expressly part of the Work:
- .1 the observing party shall immediately report the circumstances to the other party in writing;
 - .2 the Contractor shall immediately take all reasonable steps, including stopping the Work if necessary, to ensure that no individual suffers injury, sickness or death and that no property is damaged as a result of exposure to or the presence of the mould; and
 - .3 if the Owner and Contractor do not agree on the existence, significance or cause of the mould or as to what steps need be taken to deal with it, the Owner shall retain and pay for an independent qualified expert to investigate and determine such matters. The expert's report shall be delivered to the Owner and Contractor.
- 4.4.2 If the Owner and Contractor agree, or if the expert referred to in GC 4.4.1.3 determines that the presence of mould was caused by the Contractor's operations under the Agreement, the Contractor shall promptly, and in no event later than within ten (10) Working Days after such agreement or determination, as applicable, at the Contractor's own cost:
- .1 take all reasonable and necessary steps to safely remediate or dispose of the mould;
 - .2 make good any damage to the Work, the Owner's property or property adjacent to the Site as provided in GC 4.1.1; and
 - .3 reimburse the Owner for reasonable Losses incurred under GC 4.4.1.3.
- 4.4.3 If the Owner and Contractor agree, or if the expert referred to in GC 4.4.1.3 determines that the presence of mould was not caused by the Contractor's operations under the Agreement, the Owner shall promptly, and in no event later than within ten (10) Working Days after such agreement or determination, as applicable, at the Owner's own cost:

Construction Agreement

Schedule D – General Conditions

- .1 take all reasonable and necessary steps to safely remediate or dispose of the mould;
- .2 reimburse the Contractor for the cost of taking the steps under GC 4.4.1.2 and making good any damage to the Work as provided in GC 4.1.2; and
- .3 extend the Contract Time for such reasonable time as the Contract Administrator may recommend in consultation with the Contractor and the expert referred to in GC 4.4.1.3 and reimburse the Contractor for reasonable Losses incurred as a result of the delay but excluding any consequential, indirect or special damages and loss of profit, loss of opportunity or loss of productivity.

4.4.4 If either party does not accept the expert's finding under GC 4.4.1.3, the disagreement may be settled in accordance with 12. DISPUTE RESOLUTION. If such disagreement is not resolved within thirty (30) Calendar Days, the parties shall act immediately in accordance with the expert's determination and take the steps required by GC 4.4.2 or 4.4.3, it being understood that by so doing neither party will jeopardize any Claim the party may have to be reimbursed as provided by 4.4 - MOULD.

4.5 ARTIFACTS AND FOSSILS

4.5.1 Fossils, coins, articles of value or antiquity, structures and other remains or things of scientific or historic interest discovered at the Place or Work shall, as between the Owner and the Contractor, be deemed to be the absolute property of the Owner.

4.5.2 The Contractor shall take all reasonable precautions to prevent removal or damage to discoveries as identified in GC 4.5.1, and shall immediately notify the Contract Administrator upon discovery of such items and shall suspend the Work within any area identified by the Contract Administrator. Initial notification may be verbal provided that such notice is confirmed in writing by the Contractor within two (2) Calendar Days of discovery.

4.5.3 The Contract Administrator will investigate the impact on the Work of the discoveries identified in GC 4.5.1. If conditions are found that would cause an increase or decrease in the Contractor's cost or time to perform the Work, the Contract Administrator, with the Owner's approval, will issue appropriate instructions for a change in the Work as provided in 7.2 - CHANGE ORDER or 7.3 - CHANGE DIRECTIVE.

4.6 CONTRACT PRICE AND PAYMENT

4.6.1 The Contract Price, which excludes Value Added Taxes, is described in paragraph 2.1 of Section 2 of the Agreement – CONTRACT PRICE.

Construction Agreement
Schedule D – General Conditions

4.7 OWNER’S OBLIGATION TO PAY

- 4.7.1 Subject to the provisions of the Agreement, and in accordance with the Construction Act, the Owner shall:
- .1 in respect of Fixed Price Work, make progress payments and, if any, milestone payments to the Contractor for amounts undisputed by the Owner on account of the Fixed Price when due, together with such Value Added Taxes as may be applicable to such payments;
 - .2 in respect of Unit Price Work, make progress payments to the Contractor for amounts undisputed by the Owner on account of the Total Price of Unit Price Work when due, together with such Value Added Taxes as may be applicable to such payments;
 - .3 upon Substantial Performance of the Work, pay to the Contractor the unpaid balance of the ten percent (10%) portion of the Lien Holdback when due together with such Value Added Taxes as may be applicable to such payment; and
 - .4 upon Total Performance of the Work, pay to the Contractor the unpaid amount of the Contract Price and the finishing portion of the Lien Holdback when due together with such Value Added Taxes as may be applicable to such payments.
- 4.7.2 Payment of the Contract Price shall be full compensation for all labour, services, Contractor Parties, Construction Equipment and Products required in the performance of the Unit Price Work, including, hand tools, supplies and other incidentals.
- 4.7.3 The Unit Prices shall not be adjusted during the term of the Agreement other than as provided for in Schedule B – Pricing Form.
- 4.7.4 Payment for any Unit Price Work not specifically detailed as part of any one item of Unit Price Work and without specified details of payment shall be deemed to be included in the items of Unit Price Work with which it is associated.
- 4.7.5 Advance payments for Products not yet incorporated into the Work (whether or not delivered to the Site) shall not be made by the Owner without the prior written consent of the Owner, in its sole and absolute discretion. Any such advance payment shall be made on terms as agreed to by the Owner and Contractor (such terms may include transfer of title, the Contractor’s responsibility for risk of Loss and off-site storage requirements).
- 4.7.6 In the event of Losses occurring where payment becomes due under the all risk property insurance policies, payments shall be made to the Contractor in accordance with the provisions of 8.1 – INSURANCE.
- 4.8 PROPER INVOICES**
- 4.8.1 After the Commencement Date, Proper Invoices shall be given to the Owner monthly for each Invoice Period as the Work progresses, unless otherwise specified in row

Construction Agreement
Schedule D – General Conditions

B.9 of the Information Sheet. Proper Invoices shall be given to the Owner by giving it to the Owner Representative in accordance with row B.10 of the Information Sheet.

4.8.2 If the Contractor is performing Unit Price Work, the Contract Administrator or Owner Representative shall make an Estimate of Units once an Invoice Period, in writing. The first Estimate of Units shall be in respect of the Unit Price Work performed since the Contractor commenced the Unit Price Work, and every subsequent Estimate of Units, except the final one, shall be in respect of the Unit Price Work performed since the preceding Estimate of Units was made. The Contract Administrator or Owner Representative, as applicable, shall provide a copy of each such Estimate of Units to the Contractor on or before the 5th Calendar Day after the end of the Invoice Period (or the next Working Day following such date if such date is not a Working Day).

4.8.3 For all Work, the Contractor shall submit a draft invoice to the Contract Administrator:

- .1 at the invoice meeting held on or before the 7th Calendar Day after the end of the Invoice Period (or the next Working Day following such date if such date is not a Working Day) to which the Proper Invoice relates; or
- .2 on or before the 7th Calendar Day after the end of the Invoice Period (or the next Working Day following such date if such date is not a Working Day) to which the Proper Invoice relates, in such form of written or electronic communication as agreed to by the parties.

If the Contractor submits the draft invoice in accordance with GC 5.3.3.1, then the Contract Administrator, the Owner and the Contractor shall review such draft invoice at such meeting or, if the Contractor submits the draft invoice in accordance with GC 5.3.3.2, then the Contractor Administrator and the Owner shall review such draft invoice and, prior to the 14th Calendar Day after the end of such Invoice Period, the Owner and the Contract Administrator may provide the Contractor with suggested revisions to the draft invoice based upon the progress of the Work, the Contract Administrator's or Owner Representative's, as applicable, Estimate of Units and other relevant considerations. The draft invoice shall be submitted in the same format (and with the same content) as the Proper Invoice.

4.8.4 On the 14th Calendar Day after the end of the Invoice Period to which the Proper Invoice relates, the Contractor shall give a Proper Invoice to the Owner. In preparing the Proper Invoice, the Contractor should take into consideration revisions proposed by the Contract Administrator and the Owner from the draft invoice process including any reconciliations with the Contract Administrator's or Owner Representative's, as applicable, Estimate of Units. Incorporating such revisions will reduce the likelihood of the Owner issuing a notice of non-payment pursuant to GC 5.4.1.3 but is without prejudice to any rights or remedies of the Owner under the Agreement or otherwise. For clarity:

- .1 a Proper Invoice shall not be rendered incompliant with the requirements of the Agreement solely by reason of a failure to incorporate any such proposed revisions including any reconciliation with the Contract Administrator's or Owner Representative's, as applicable, Estimate of Units; and

Construction Agreement
Schedule D – General Conditions

.2 the Contractor may only give to the Owner a Proper Invoice on the 14th Calendar Day after the end of the Invoice Period to which the Proper Invoice relates, and the Contractor shall not give to the Owner a Proper Invoice on any other Calendar Day. Any Proper Invoice received by the Owner on any Calendar Day:

- (1) earlier than the 14th Calendar Day after the end of such Invoice Period shall be deemed to have been received by the Owner on the 14th Calendar Day after the end of such Invoice Period; or
- (2) later than the 14th Calendar Day after the end of such Invoice Period shall be deemed to have been received by the Owner on the Calendar Day of such delivery,

and if the date on which the Proper Invoice is received under GC 5.3.4.2, or is deemed to have been received under GC 5.3.4.2(1) or (2), is not a Working Day, then it shall be deemed to be received on the next Working Day.

4.8.5 The amount applied for in each Proper Invoice shall be:

.1 for Fixed Price Work:

- (1) relating to milestones set out in the Agreement, the portion of the Fixed Price attributable to the milestones which the Owner has agreed have been completed on or before the last Calendar Day of the Invoice Period to which the Proper Invoice relates except for milestones dealt with in prior Proper Invoices;
- (2) not relating to milestones set out in the Agreement, the value, proportionate to the Fixed Price not attributable to the milestones, of such Fixed Price Work performed to the last Calendar Day of the Invoice Period to which the Proper Invoice relates less the value of such Fixed Price Work previously invoiced in prior Proper Invoices;

.2 for Unit Price Work, the aggregate of the total units for each item of the Unit Price Work performed to the last Calendar Day of the Invoice Period to which the Proper Invoice relates multiplied by the applicable Unit Price of each such item, less the value of all Unit Price Work previously invoiced in prior Proper Invoices; and

.3 for T&M Changes in the Work, an amount equal to:

- (1) the total T&M Price of all T&M Changes in the Work performed to the last Calendar Day of the month to which the Proper Invoice relates; less
- (2) the total T&M Price of all T&M Changes in the Work in respect of all prior Proper Invoices,

calculated in accordance with Section 3 of Schedule E – Valuing Changes in the Work.

Construction Agreement

Schedule D – General Conditions

For clarity, the amount applied for in each Proper Invoice shall not include any amounts included in any Claim Notice unless and until the Owner or the Contract Administrator, as the case may be, has issued a determination to the Contractor regarding the validity of such Claim Notice pursuant to GC 7.7.6.

4.8.6 Schedule of Values

- .1 The Contractor shall submit to the Contract Administrator, within fourteen (14) Calendar Days of the Effective Date and prior to the first Proper Invoice, a schedule of values with a detailed breakdown of the Fixed Price Work not relating to milestones, aggregating the total amount of the Fixed Price not attributable to the milestones, so as to facilitate evaluation of Proper Invoices.
- .2 The schedule of values shall:
 - (1) be made out in such form and supported by such evidence as the Contract Administrator may reasonably direct;
 - (2) include a fair and reasonable value for the preparation and completion of the As-Built Drawings; and
 - (3) include the fixed price for the bonds and insurance to be maintained by the Contractor in compliance with the requirements of the Agreement and provide for the payment of such fixed price for the bonds and insurance in amounts proportionate to the payment of the Fixed Price not attributable to the milestones unless otherwise agreed to by the Contract Administrator.
- .3 When accepted by the Contract Administrator, the schedule of values shall be used as the basis for evaluating Fixed Price Work not relating to the milestones in Proper Invoices, unless both parties agree the schedule of values is in error.
- .4 The Owner, acting reasonably, reserves the right to modify costs allocated to the various breakdown items in the schedule of values during the performance of the Work to prevent front loading.

4.8.7 The Proper Invoice shall be in a form similar to Form 1 of Schedule G – Sample Proper Invoice and shall, to the extent applicable:

- .1 include the following information, to the extent such information is not included in any schedule of values:
 - (1) the Contractor's name, telephone number and mailing address, and contact information of the Contractor Project Manager;
 - (2) remittance payment information;
 - (3) Proper Invoice number;
 - (4) the date of the Proper Invoice and the Invoice Period during which the Work was performed;

Construction Agreement

Schedule D – General Conditions

- (5) the Contract number;
 - (6) purchase order number
 - (7) contact information of the Owner's Representative and Contract Administrator;
 - (8) a description of the Project;
 - (9) percentage of Work completed to date;
 - (10) a description of the Work performed during the Invoice Period and a specific itemization of the Work with quantities where appropriate including:
 - (A) the Contract Administrator's or Owner Representative's, as applicable, Estimate of Units; and
 - (B) the Contractor's Estimate of Units;
 - (11) the total Contract Price and the amount of the Contract Price previously paid;
 - (12) the value of Work and changes in the Work performed to date itemized by Change Order; and
 - (13) the amount payable for the Work and changes in the Work performed during the Invoice Period;
- .2 include the schedule of values;
 - .3 include a detailed description of expenditures under the Cash Allowance and Provisional Allowance;
 - .4 include Daily Contractor Work Records;
 - .5 include evidence of compliance with worker's compensation legislation including a WSIB clearance certificate;
 - .6 include a statutory declaration using the latest form CCDC 9A - 2018 Statutory Declaration of Progress Payment Distribution by Contractor, confirming that all accounts of the Contractor have been paid in full up to and including the latest progress payment received;
 - .7 for advance payment, if applicable, for Products not yet incorporated into the Work:
 - (1) list such Products (and the advance payment calculations in respect thereof) as a separate line item; and

Construction Agreement
Schedule D – General Conditions

- (2) be supported by invoices and such other evidence as the Contract Administrator may reasonably request to establish the value and delivery of such Products;
 - .8 list the Lien Holdback, Contractual Holdback and any other holdbacks provided for under this Contract as a separate line item;
 - .9 include the Contractor's registration number for Value Added Taxes and list the total amount of Value Added Taxes separate from the total Contract Price;
 - .10 include a copy of the latest Current Schedule delivered in compliance with the applicable requirements of 3.5 – CONSTRUCTION SCHEDULE; and
 - .11 include such other information and documents: (1) identified elsewhere in the Agreement; or (2) as required under the Construction Act.
- 4.8.8 A Proper Invoice may be revised by the Contractor after it has submitted the Proper Invoice to the Owner, if:
- .1 the Owner agrees in advance to the revision;
 - .2 the date of the Proper Invoice is not changed; and
 - .3 the Proper Invoice continues to be in compliance with the requirements of GC 5.3.7.
- 4.9 PROGRESS PAYMENT**
- 4.9.1 After receipt by the Contract Administrator of a Proper Invoice submitted by the Contractor in accordance with 5.3 – PROPER INVOICES:
- .1 the Contract Administrator shall promptly inform the Owner of the date of receipt of the Proper Invoice;
 - .2 the Contract Administrator shall, no later than the number of Calendar Days or Working Days, as applicable, after the receipt of the Proper Invoice identified in row C.8 of the Information Sheet, issue to the Owner and copy to the Contractor, a certificate for payment in the amount applied for, or in such other undisputed amount as the Contract Administrator determines to be properly due; and
 - .3 if the Contract Administrator, or the Owner independent of the Contract Administrator, disputes all or any portion of the amount applied for in such Proper Invoice, the Owner shall promptly, but no later than fourteen (14) Calendar Days after the Contract Administrator's receipt of the Proper Invoice from the Contractor, provide the Contractor a notice of non-payment in the form and manner prescribed by the Construction Act specifying the amount that is not being paid and detailing all of the reasons for such non-payment.
- 4.9.2 The Owner shall, no later than twenty-eight (28) Calendar Days after the receipt of the Proper Invoice, make payment to the Contractor of the amount set out in the

Construction Agreement
Schedule D – General Conditions

Proper Invoice less the amount disputed by the Contract Administrator or the Owner independent of the Contract Administrator, as applicable, that is set out in the notice of non-payment issued pursuant to GC 5.4.1.3. For clarity, progress payments for Unit Price Work shall be based on Estimates and as such shall be construed and held to be approximate. Subject to section 1.1 of Schedule E – Valuing Changes in the Work, the final quantities of total units for each item of the Unit Price Work performed for the Proper Invoice submitted pursuant to GC 5.7.1.1 shall be based on actual field measurements of the Unit Price Work completed. The Owner shall retain the Contractual Holdback, Lien Holdback and any other holdbacks provided for under this Contract as a separate line item from such payment and may retain any other amount pursuant to 5.10 - OWNER'S SET-OFF. Unless otherwise specified in the Agreement, no letter of credit or demand-worded holdback shall be accepted or used to retain any part of the Lien Holdback.

- 4.9.3 For clarity, if the Contractor fails to submit a Proper Invoice to the Contract Administrator which is in compliance with the requirements of GC 5.3.7, the Owner shall not be required to make payment to the Contractor within the twenty-eight (28) Calendar Day period set out in GC 5.4.2. Such twenty-eight (28) Calendar Day period shall not commence until such time as the Contract Administrator has received from the Contractor a Proper Invoice in compliance with the requirements of GC 5.3.7.

4.10 SUBSTANTIAL PERFORMANCE OF THE WORK

- 4.10.1 When the Contractor considers that Substantial Performance of the Work has been attained the Contractor shall, within one (1) Working Day, deliver to the Contract Administrator and to the Owner a comprehensive list of items to be completed or corrected, together with a written application for a review by the Contract Administrator to establish Substantial Performance of the Work. Failure to include an item on the list does not alter the responsibility of the Contractor to complete the Agreement. Such written application shall include the proof required by the Agreement including the Specifications to demonstrate that the Work has been substantially performed in conformance with the requirements of the Construction Act.
- 4.10.2 The Contract Administrator shall review the Work to verify the validity of the written application for Substantial Performance of the Work and shall promptly, and in any event, no later than twenty (20) Calendar Days after receipt of the Contractor's list and application:
- .1 advise the Contractor in writing that the Work is not substantially performed and give reasons why, or
 - .2 set out the date of Substantial Performance of the Work in the certificate of Substantial Performance of the Work and issue a copy of such certificate to each of the Owner and the Contractor within seven (7) Calendar Days after signing such certificate. The certificate of Substantial Performance of the Work shall be in the form prescribed by the Construction Act.
- 4.10.3 Immediately following the issuance of the certificate of Substantial Performance of the Work, the Contractor shall prepare and submit to the Owner and the Contract Administrator a schedule for completing the Work and correcting all Deficiencies,

Construction Agreement
Schedule D – General Conditions

which establishes the date for the Total Performance of the Work. Upon the Owner and the Contract Administrator's approval of such schedule, the Construction Schedule shall be deemed to be amended to include such schedule. The date for Total Performance of the Work identified in such schedule shall not be later than the Scheduled Date for Total Performance of the Work.

- 4.10.4 Upon receipt of a copy of the certificate of Substantial Performance of the Work, the Contractor shall forthwith, as required by section 32(1) of the Construction Act, publish a copy of the certificate in the manner set out in the regulations. If the Contractor fails to publish a copy of the certificate of Substantial Performance of the Work within seven (7) Calendar Days after receiving a copy of such certificate, the Owner may publish a copy of such certificate at the Contractor's cost.

4.11 PAYMENT OF LIEN HOLDBACK UPON SUBSTANTIAL PERFORMANCE OF THE WORK

- 4.11.1 After the date on which all liens that may be claimed against the Lien Holdback have expired or been satisfied, discharged or otherwise provided for under the Construction Act and provided the certificate of Substantial Performance of the Work has been published in accordance with 5.5, the Contractor shall submit a Proper Invoice for the Lien Holdback, which shall, in addition to complying with the requirements of GC 5.3.7, include the following items in order to be considered a "Proper Invoice" for the purposes of GC 5.6.2:

- .1 the list of Claims required by GC 9.2.1;
- .2 the value of outstanding or incomplete Work; and
- .3 a representation and warranty from the Contractor that, as of the date of the Proper Invoice, the only Adjudications in respect of disputes as described in GC 12.2.16 are Adjudications which the Contractor has provided Notice in Writing of to the Owner in accordance with GC 12.2.16.

- 4.11.2 After the receipt of a Proper Invoice from the Contractor in compliance with the requirements of GC 5.6.1, the Contract Administrator shall issue a certificate for payment of the Lien Holdback.

- 4.11.3 Subject to GC 5.6.4 and the Construction Act, the Owner shall, no later than fifteen (15) Working Days after the receipt of the Proper Invoice, make payment to the Contractor of the amount of the Lien Holdback set out in the Proper Invoice. Subject to the Construction Act, the Owner may retain out of the Lien Holdback any sums required by law to satisfy any liens against the Work and any other amount pursuant to 5.10 - OWNER'S SET-OFF.

- 4.11.4 The Owner may refuse to pay some or all of the Lien Holdback the Owner is required to pay to the Contractor pursuant to GC 5.6.3 if:

- .1 no later than forty (40) Calendar Days after publication of the certificate of Substantial Performance of the Work in accordance with GC 5.5.4, the Owner publishes, in the manner set out in the Construction Act, a notice in the form

Construction Agreement

Schedule D – General Conditions

prescribed by the Construction Act, specifying the amount of the Lien Holdback that the Owner refuses to pay; and

- .2 the Owner notifies the Contractor, in accordance with the Construction Act, of the publication of such notice.

4.11.5 For clarity, if the Contractor fails to submit a Proper Invoice to the Contract Administrator which is in compliance with the requirements of GC 5.6.1, the Owner shall not be required to make payment to the Contractor within the fifteen (15) Working Day period set out in GC 5.6.3. Such fifteen (15) Working Day period shall not commence until such time as the Contract Administrator has received from the Contractor a Proper Invoice in compliance with the requirements of GC 5.6.1.

4.12 PAYMENTS UPON TOTAL PERFORMANCE OF THE WORK

4.12.1 Payment Upon Total Performance of the Work

- .1 When the Contractor considers that the Work is Totally Performed, the Contractor shall submit a Proper Invoice for payment of the unpaid amount of the Contract Price other than the finishing portion of the Lien Holdback.
- .2 The Contractor's Proper Invoice submitted in accordance with GC 5.7.1.1 shall, in addition to complying with the applicable requirements of GC 5.3.7, include the list of Claims required by GC 9.2.2 in order to be considered a "Proper Invoice" for the purposes of GC 5.7.1.5.
- .3 The Contract Administrator shall, no later than ten (10) Calendar Days after the receipt of a Proper Invoice from the Contractor submitted in accordance with GC 5.7.1.1, review the Work to verify the validity of such Proper Invoice. If the Contract Administrator, or the Owner independent of the Contract Administrator, disputes the validity of such Proper Invoice, the Owner shall promptly, but no later than fourteen (14) Calendar Days after the Contract Administrator's receipt of such Proper Invoice from the Contractor, provide the Contractor a notice of non-payment in the form and manner prescribed by the Construction Act specifying the amount that is not being paid and detailing all of the reasons why such Proper Invoice is invalid. No later than twenty-eight (28) Calendar Days after the receipt by the Contract Administrator of such Proper Invoice, the Owner shall make payment to the Contractor of the amount set out in such Proper Invoice less the amount disputed by the Contract Administrator or the Owner independent of the Contract Administrator, as applicable, that is set out in a notice of non-payment. If such Proper Invoice is invalid, then the Contractor shall then submit another Proper Invoice when it considers that the Work is Totally Performed and the process described in this GC 5.7.1 shall repeat.
- .4 When the Contract Administrator finds the Proper Invoice submitted in accordance with GC 5.7.1.1 is valid and in compliance with the requirements of GC 5.7.1.2, the Contract Administrator shall promptly issue a certificate for payment which shall set out the date of Total Performance of the Work.

Construction Agreement
Schedule D – General Conditions

- .5 The Owner shall, no later than twenty-eight (28) Calendar Days after the receipt by the Contract Administrator of a Proper Invoice submitted in accordance with GC 5.7.1.1 pay the Contractor as provided in 5.2 - OWNER'S OBLIGATION TO PAY less any amount disputed by the Contract Administrator or the Owner independent of the Contract Administrator, as applicable, that is set out in a notice of non-payment issued pursuant to GC 5.4.1.3 (including amounts in respect of Deficiencies identified after the receipt of the Proper Invoice).
- .6 For clarity, if the Contractor fails to submit a Proper Invoice to the Contract Administrator which is in compliance with the requirements of GC 5.7.1.1, the Owner shall not be required to make payment to the Contractor within the twenty-eight (28) Calendar Day period set out in GC 5.6.3. Such twenty-eight (28) Calendar Day period shall not commence until such time as the Contract Administrator has received from the Contractor a Proper Invoice in compliance with the requirements of GC 5.7.1.1.

4.12.2 Payment of the Finishing Portion of the Lien Holdback

- .1 After the date on which all liens that may be claimed against the finishing portion of the Lien Holdback have expired or been satisfied, discharged or otherwise provided for under the Construction Act and provided the Contract Administrator has certified that the Work is Totally Performed in accordance with GC 5.7.1, the Contractor shall submit a Proper Invoice for the finishing portion of the Lien Holdback.
- .2 When the Contract Administrator finds the Proper Invoice submitted in accordance with GC 5.7.2.1 is valid and in compliance with the requirements of GC 5.7.2.1, the Contract Administrator shall promptly issue a certificate of payment for the finishing portion of the Lien Holdback.
- .3 Subject to GC 5.7.2.4 and the Construction Act, the Owner shall, no later than fifteen (15) Working Days after the receipt of the Proper Invoice, make payment to the Contractor of the amount of the finishing portion of the Lien Holdback set out in the Proper Invoice. Subject to the Construction Act, the Owner may retain out of the finishing portion of the Lien Holdback any sums required by law to satisfy any liens against the Work and any other amount pursuant to 5.10 - OWNER'S SET-OFF.
- .4 The Owner may refuse to pay some or all of the finishing portion of the Lien Holdback the Owner is required to pay to the Contractor pursuant to GC 5.7.2.3 if:
 - (1) no later than forty (40) Calendar Days after the date of Total Performance of the Work, the Owner publishes, in the manner set out in the Construction Act, a notice in the form prescribed by the Construction Act, specifying the amount of the finishing portion of the Lien Holdback that the Owner refuses to pay; and
 - (2) the Owner notifies the Contractor, in accordance with the Construction Act, of the publication of such notice.

Construction Agreement

Schedule D – General Conditions

- .5 For clarity, if the Contractor fails to submit a Proper Invoice to the Contract Administrator which is in compliance with the requirements of GC 5.7.2.1, the Owner shall not be required to make payment to the Contractor within the fifteen (15) Working Day period set out in GC 5.6.3. Such fifteen (15) Working Day period shall not commence until such time as the Contract Administrator has received from the Contractor a Proper Invoice in compliance with the requirements of GC 5.7.2.1.

4.13 FINAL ACCEPTANCE CERTIFICATE

- 4.13.1 The Contract Administrator shall issue the final acceptance certificate ("**Final Acceptance Certificate**") after the later of the:

- .1 date on which the Contract Administrator determines that the Work has passed all inspection and testing requirements and is satisfied that the Contractor has corrected all Deficiencies and has discharged all of the Contractor's obligations under the Agreement; and
- .2 expiry of the Warranty Period.

The Contract Administrator shall have no obligation to issue the Final Acceptance Certificate until all known Deficiencies have been corrected and the Contractor has discharged all obligations under the Agreement.

4.14 CONTRACTOR DISCHARGE OF LIABILITIES

- 4.14.1 In addition to the obligations assumed by the Contractor pursuant to 3.8 – SUBCONTRACTORS AND SUPPLIERS, the Contractor agrees to discharge all liabilities and obligations for the Work including in respect of labour, services, Contractor Parties, Construction Equipment and Products, except for amounts withheld by reason of legitimate dispute and which have been identified to the party or parties, from whom payment has been withheld.

4.15 OWNER'S SET-OFF

- 4.15.1 In addition to and without limiting any other rights the Owner may have under the Agreement and at law or otherwise, the Owner may set-off and deduct from any amount owing to the Contractor under the Agreement (including any payments by the Owner pursuant to GC 5.4.2, GC 5.6.3, GC 5.7.1.5, GC 5.7.2.3 and determinations pursuant to an Adjudication) an amount sufficient to cover:
 - .1 any outstanding or disputed liabilities or obligations of the Contractor to the Owner (including unpaid liquidated damages), or to the Indemnities pursuant to 9.1 – INDEMNIFICATION;
 - .2 any Losses or amounts for which the Owner is expressly entitled in the Agreement to set-off or retain including GC 2.5.5, GC 5.4.2, GC 5.6.3, GC 5.7.2.3, GC 11.1.5.1, GC 11.1.5.2, GC 4.1.5, GC 10.2.5, GC 8.1.11.3, GC 9.1.3 GC 9.1.6, GC 13.2.1.2 and GC 13.2.2;

Construction Agreement
Schedule D – General Conditions

- .3 any of the following:
 - (1) any assessment due to the Workplace Safety and Insurance Board relating to the Work; and
 - (2) any amount necessary to satisfy Contractor's obligations under 5.9 – CONTRACTOR DISCHARGE OF LIABILITIES;
- .4 any other amounts owed by the Contractor to the Owner under the Agreement; and
- .5 if the Contractor becomes insolvent, all outstanding Claims and Losses of the Owner whether or not related to the Agreement.

If there is an insufficient amount owing by the Owner to the Contractor, then the Contractor shall reimburse the Owner for all of the aforementioned Claims and Losses.

5. ALLOWANCES

5.1 ALLOWANCES

- 5.1.1 The Fixed Price or Total Price of Unit Price Work includes the Allowances, if any. The Allowances include all taxes and duties (except only Value Added Taxes).
- 5.1.2 The Contractor's overhead and profit for the Cash Allowance is included in the Fixed Price or Total Price of Unit Price Work, and not in the Cash Allowance itself. Each Provisional Allowance item includes the Contractor's overhead and profit in connection with such Provisional Allowance. The Contractor shall not be paid any additional overhead and profit in connection with the Allowances other than as provided for in this 6.1 - ALLOWANCES.
- 5.1.3 Expenditures under Allowances shall be pre-authorized by the Owner in writing through the Contract Administrator.
- 5.1.4 Where the actual cost of the Work under any individual Cash Allowance exceeds the amount of such Cash Allowance, any unexpended amounts from other Cash Allowances may be reallocated, at the Owner's direction, to cover the shortfall, and, in that case, there shall be no additional amount added to the Fixed Price for overhead and profit. Only where the actual cost of the Work under all Cash Allowances exceeds the total amount of all Cash Allowances shall the Contractor be compensated for the excess incurred and substantiated, plus an amount for overhead and profit on such excess, as set out in row B.5 of the Information Sheet, and the Fixed Price shall be adjusted accordingly by Change Order.
- 5.1.5 The total amount of any unexpended Allowances shall be deducted from the Fixed Price or Total Price of Unit Price Work by Change Order, after providing for any reallocation contemplated in GC 6.1.4. For Provisional Allowances, such deduction includes the Contractor's overhead and profit included in such total amount. For clarity, no adjustment shall be made for the Contractor's overhead and profit included

Construction Agreement

Schedule D – General Conditions

in the Fixed Price or Total Price of Unit Price Work on such total amount deducted in respect of Cash Allowances.

- 5.1.6 The value of the Work performed under an Allowance is eligible to be included in Proper Invoices.
- 5.1.7 The Contractor and the Contract Administrator shall jointly prepare a schedule that shows when the Contract Administrator and Owner must authorize ordering of items called for under Allowances to avoid delaying the progress of the Work.
- 5.1.8 The Contractor shall extend to the Owner all refunds and trade, quantity and cash discounts, rebates and refunds which may be received in purchasing under Allowances.
- 5.1.9 The Owner reserves the right to call, or to have the Contractor call, competitive bids or other types of procurements for portions of the Work to be paid for from Allowances. If the Owner determines to proceed with competitive bids, the Contractor shall comply with the directions of the Owner.
- 5.1.10 The Contractor shall include copies of Contractor Records substantiating purchases under Allowances.

6. CHANGES IN THE WORK

6.1 OWNER'S RIGHT TO MAKE CHANGES

- 6.1.1 The Owner, through the Contract Administrator, without invalidating the Agreement, may make:
 - .1 changes in the Work consisting of additions, deletions or other revisions to the Work by Change Order or Change Directive; and
 - .2 changes to the Contract Time for the Work, or any part thereof, by Change Order or Change Directive.
- 6.1.2 The Contractor shall not perform a change in the Work without a Change Order or a Change Directive. To the extent the Contractor performs any such change in the Work, the Contractor does so at its own risk and without any liability or obligation on the part of the Owner. There shall be no change in the Contract Price (including delay prolongation costs, remobilization costs or other compensation), extension of the Contract Time or other amendment to the Agreement on account of any change in the Work unless specified in, and initiated through, a Change Order or a Change Directive.
- 6.1.3 There shall be no extension of the Contract Time or increase in the Contract Price or payment of any kind whatsoever (including for loss of productivity) based on the aggregate quantity, scope or value of changes in the Work whether resulting from Change Order or Change Directive. The Contractor agrees that in connection with any Change Order or Change Directive it shall co-operate with the Owner and the Contract Administrator and shall carry out such Change Order or Change Directive in

Construction Agreement

Schedule D – General Conditions

such a manner as to avoid incurring or to minimize any additional Losses to be incurred as a result of such Change Order or Change Directive or delay in the performance of the Work.

- 6.1.4 The value of a change shall be determined as follows, at the sole discretion of the Owner, as indicated in the Contemplated Change Order or Change Directive, as applicable:
- .1 if the change relates to items for which the Unit Prices set out in the Agreement are applicable, in accordance with Section 1 of Schedule E – Valuing Changes in the Work; or
 - .2 in the absence of applicable Unit Prices set out in the Agreement:
 - (1) on either a negotiated fixed price or unit price basis, in accordance with the provisions in Section 2 of Schedule E – Valuing Changes in the Work; or
 - (2) if the Parties are unable to agree on a fixed price or unit price pursuant to GC 7.1.4.2(1), on a time and material basis, in accordance with the provisions in Section 3 of Schedule E – Valuing Changes in the Work.
- 6.1.5 Without limiting the entitlement of the Contractor pursuant to GC 11.1.9.2 when there is a termination for convenience pursuant to GC 11.1.9.1, if any change in the Work is made by which the amount of Work to be done is decreased, or any portion of the Work is dispensed with, the Owner shall not be liable to the Contractor for any consequential, indirect or special damages and loss of profit, loss of opportunity or loss of productivity.
- 6.1.6 Subject to any entitlement of the Contractor expressly provided for under the Agreement, no course of conduct or dealing between the parties, no express or implied acceptance of additions, deletions or other revisions to the Work, and no Claims that the Owner has been unjustly enriched by any addition, deletion or other revision to the Work, whether in fact there is any such unjust enrichment or not, shall be the basis of a Claim Notice or any other Claim for additional payment under the Agreement or a Claim Notice for any extension of the Contract Time or any other Claim.
- 6.2 CHANGE ORDER**
- 6.2.1 When a change in the Work is proposed or required by the Owner, the Contract Administrator will provide the Contractor with a written description of the proposed change in the Work (a “**Contemplated Change Order**”). The Contractor shall promptly but in no event later than ten (10) Working Days (or such other period set out in row C.9 of the Information Sheet) after receipt of a Contemplated Change Order submit, in a form acceptable to the Contract Administrator, a method of adjustment or an amount of adjustment for the Contract Price, if any, and the adjustment in the Contract Time, if any, for the proposed change in the Work.
- 6.2.2 Subject to GC 7.1.4, when the Owner and Contractor agree to the adjustments in the Contract Price and Contract Time or to the method to be used to determine the

Construction Agreement

Schedule D – General Conditions

adjustments, such agreement shall be reflected in a Change Order. The value of the Work performed as the result of a Change Order shall be included in the Proper Invoice.

- 6.2.3 A Change Order shall be a final determination or adjustment in the Contract Time, Contract Price and any other amendment to the Agreement as a result of the change in the Work and shall constitute a full and final settlement and satisfaction of all consequences to the Contractor of such change in the Work and shall be deemed to compensate Contractor fully for all effects of such change in the Work. For clarity, if a Change Order does not address an adjustment in the Contract Time, Contract Price or any other amendment to the Agreement, as the case may be, there shall be no adjustment in the Contract Time, Contract Price or any other amendment to the Agreement, as the case may be as a result of the change in the Work provided for in such Change Order.

6.3 CHANGE DIRECTIVE

- 6.3.1 If the Owner requires the Contractor to proceed with a change in the Work prior to the Owner and the Contractor agreeing upon the corresponding adjustment in Contract Price and/or Contract Time the Owner, through the Contract Administrator, shall issue a Change Directive.
- 6.3.2 Without limiting GC 7.3.1, a Change Directive may be used to direct a change in the Work that is only a change in the Construction Schedule or Contract Time.
- 6.3.3 Upon receipt of a Change Directive, the Contractor shall proceed immediately with the change in the Work.
- 6.3.4 The adjustment in the Contract Price, if any, for a change carried out by way of a Change Directive shall be determined in accordance with GC 7.1.4.
- 6.3.5 Without limitation to GC 7.3.3, upon receipt of a Change Directive, the Contractor shall promptly provide the Owner with an estimate of the cost of the performance of the change in the Work contemplated in the Change Directive and the impact on the Construction Schedule, if applicable, but in no event later than ten (10) Working Days (or such other period set out in row C.10 of the Information Sheet) after receipt of the Change Directive. If the Contractor, acting reasonably, requires more time to provide an estimate, it may notify the Owner of the date when the estimate will be provided.
- 6.3.6 Without limitation to GC 7.3.3, when the Owner and the Contractor reach agreement in respect of a Change Directive on the adjustment to the Contract Price and to the Contract Time, if any, such agreement shall be reflected in a Change Order. The Contractor shall not be entitled to include the value of the change in the Work performed as the result of such Change Directive in its Proper Invoices until, and unless, such Change Order has been executed.

6.4 CONCEALED OR UNKNOWN CONDITIONS

- 6.4.1 If the Owner or the Contractor discover conditions at the Site which are:

Construction Agreement
Schedule D – General Conditions

- .1 subsurface or otherwise concealed physical conditions which existed before the commencement of the Work which differ materially from those indicated in, or inferable from, the Agreement; or
- .2 physical conditions, other than conditions due to weather, that are of a nature which differ materially from those ordinarily found to exist and generally recognized as inherent in construction activities of the character provided for in the Agreement,

then the observing party shall give Notice in Writing to the other party of such conditions before they are disturbed and in no event later than five (5) Working Days after first observance of the conditions.

6.4.2 The Contract Administrator will promptly, and in no event later than within twenty (20) Working Days after discovery thereof by the Owner or the Contractor, investigate such conditions and make a finding having regard to and subject to the liabilities and responsibilities assumed by the Contractor pursuant to 3.6 - EXAMINATION OF SITE and GC 4.1.4. If the finding is that the conditions differ materially and, having regard to and subject to the liabilities and responsibilities assumed by the Contractor pursuant to 3.6 - EXAMINATION OF SITE and GC 4.1.4, this would cause an increase or decrease in the Contract Time or Contract Price, the Contract Administrator, with the Owner's approval, will issue appropriate instructions for a change in the Work as provided in 7.2 - CHANGE ORDER or 7.3 - CHANGE DIRECTIVE. For clarity, the Contractor's entitlement to such change in the Work shall be determined by the Contract Administrator taking into account the respective liabilities assumed by the Owner and Contractor pursuant to 3.6 - EXAMINATION OF SITE and GC 4.1.4.

6.4.3 If the Contract Administrator finds that the conditions at the Site are not materially different or that no change in the Contract Price or extension of the Contract Time is justified, the Contract Administrator will report the reasons for this finding to the Owner and the Contractor in writing.

6.4.4 If such concealed or unknown conditions relate to Hazardous Materials, artifacts and fossils, or mould, the parties will be governed by the provisions of 4.3 - HAZARDOUS MATERIALS, 4.5 - ARTIFACTS AND FOSSILS and 4.4 – MOULD, as applicable.

6.5 DELAYS

6.5.1 If the Contractor is delayed in the completion of a critical path Work activity by:

- .1 subject to GC 7.5.3, an act or omission of the Owner, the Owner Representative, the Contract Administrator or anyone employed or engaged by them directly or indirectly, which is contrary to the provisions of the Agreement; or
- .2 by a stop work order issued by a court or other public authority,

then, except to the extent such event results from the negligent act or omission of the Contractor Parties or the default or breach of the Contractor's obligations under the Agreement or any other act or fault of the Contractor Parties, the Contract Time shall

Construction Agreement

Schedule D – General Conditions

be extended for such reasonable time as agreed to by the Parties, taking into account such time period as recommended by the Contract Administrator and the Contract Price shall be adjusted to account for reasonable Losses incurred by the Contractor as the result of such delay including the Losses referred to in GC 7.5.8, as applicable, but excluding any consequential, indirect or special damages and loss of profit, loss of opportunity or loss of productivity resulting from such delay.

6.5.2 If the Contractor is delayed in the completion of a critical path Work activity by any cause beyond the Contractor's control, including:

- .1 war, blockades, and civil commotions;
- .2 labour disputes, strikes and lock-outs (other than lock-outs described in GC 7.5.3);
- .3 fire, unusual delay by common carriers or unavoidable casualties; or
- .4 abnormally adverse weather conditions at the Site which are different from those normally and customarily experienced at the Site (as documented by weather data from Environment Canada) over the past ten (10) years taking into consideration severity, duration and time of year conditions,

except to the extent such event results from the negligent act or omission of the Contractor Parties or the default or breach of the Contractor's obligations under the Agreement, then the Contract Time shall be extended for such reasonable time as agreed to by the Parties, taking into account such time period as recommended by the Contract Administrator. The extension of time shall not be less than the time lost as the result of the event causing the delay, unless the Contractor agrees to a shorter extension. The Contractor shall not be entitled to payment for Losses incurred by such delays except to the extent the Contractor would be entitled to reasonable Losses in accordance with GC 7.5.1 or if such delay is the cause of the stop work order in connection with the Contractor's termination of the Agreement pursuant to GC 11.2.1.

6.5.3 If the Contractor is delayed in the completion of a critical path Work activity by a lock-out of the Owner or the City of Toronto, except to the extent such event results from the negligent act or omission of the Contractor Parties or the default or breach of the Contractor's obligations under the Agreement:

- .1 the Contract Time shall be extended for the duration of such lock-out, provided that if the duration of such lock-out exceeds five (5) Working Days, the Contract Time shall be extended by the duration of such lock-out plus an additional (5) Working Days; and
- .2 the Contract Price shall only be adjusted to account for direct reasonable costs the Contractor incurs for leased Construction Equipment as a result of such lock-out, but excluding any consequential, indirect or special damages and loss of profit, loss of opportunity or loss of productivity resulting from such delay.

Construction Agreement

Schedule D – General Conditions

6.5.4 No extension of the Contract Time shall be made for delay unless Notice in Writing of the cause of delay is given to the Contract Administrator and Owner in accordance with 7.7.1.

6.5.5 If no:

- .1 schedule is made under GC 2.2.12 for the Contract Administrator to provide Supplemental Instruction; or
- .2 time period is provided elsewhere in the Agreement where the Contract Administrator is to provide instructions to the Contractor,

then no request for an extension of the Contract Time shall be made by the Contractor because of failure of the Contract Administrator to provide such Supplemental Instructions or other instructions, as applicable, until fifteen (15) Working Days after demand for such Supplemental Instructions or other instructions, as applicable, has been made or such longer period of time reasonably required under the circumstances.

6.5.6 If the Work is behind schedule for a reason other than as described in GC 7.5.1, 7.5.2 or 7.5.3, the Contractor, at its expense and subject to GC 7.5.7, shall:

- .1 prepare and present to the Contract Administrator and Owner, for review and approval, a recovery plan (“**Recovery Plan**”) as soon as practical, but not later than three (3) Working Days after the earlier of the Contractor becoming aware of the Work being behind schedule or the Owner notifying the Contractor that the Work is behind schedule. Such Recovery Plan shall include information and details required by the Contract Administrator and Owner, acting reasonably, and shall demonstrate how the Contractor shall achieve the recovery of the schedule and bring the Work back on schedule. Any costs incurred by the Owner for the services of the Contract Administrator in reviewing multiple submissions of the Recovery Plan shall be borne by the Contractor; and
- .2 commence the implementation of the Recovery Plan approved by the Contract Administrator and Owner as soon as practical, but not later than within two (2) Working Days of the Contract Administrator and Owner providing approval of the Recovery Plan; and
- .3 otherwise take all measures necessary to bring the Work back on schedule (including expediting, increasing the labour force, supervisors and equipment, and working overtime).

For clarity, this GC 7.5.6 shall not limit the other provisions of 7.5.

6.5.7 For greater certainty and without limiting any other provision in the Agreement, there shall be no extension of the Contract Time or increase in the Fixed Price or Unit Prices to the extent a delay was caused by the negligent act or omission of the Contractor Parties or by the Contractor’s default or breach of the Agreement. Without limiting any other provision in the Agreement, the Owner shall be reimbursed by the Contractor for all Losses incurred by the Owner as the result of such delay, including

Construction Agreement

Schedule D – General Conditions

all services required by the Owner from the Contract Administrator and Owner Representative as a result of such delay by the Contractor and, in particular, the costs of the Contract Administrator's and Owner Representative's services during the period between the Scheduled Date for Substantial Performance of the Work as the same may be extended through the provisions of the GC and the actual date of Substantial Performance of the Work achieved by the Contractor. For clarity, such costs shall be in addition to any Delay Liquidated Damages payable by the Contractor.

- 6.5.8 The Contractor shall be responsible for the care, maintenance and protection of the Work in the event of any suspension of construction as a result of the delay described in GC 7.5.1, 7.5.2 or 7.5.3. In the event of such suspension, the Contractor shall be reimbursed by the Owner for the reasonable Losses incurred by the Contractor for such care, maintenance and protection, but excluding the costs of the Contractor's head office Personnel and any consequential, indirect or special damages and loss of profit, loss of opportunity or loss of productivity.
- 6.5.9 Without limiting the generality of any other provision in the Agreement, the Contractor shall use best efforts to mitigate the impact of any delay events dealt with by GC 7.5.1, 7.5.2 or 7.5.3 and any other matters dealt with in a Claim Notice upon the performance of the Work, the Contract Time and the Contract Price. If the Contractor does not exercise such best efforts, the Contractor's entitlements under any applicable Claim Notice will be reduced or invalidated to reflect impacts that would have been avoided by such mitigation.
- 6.5.10 Any extension of the Contract Time or adjustment in the Contract Price provided for in this 7.5 – DELAYS shall be authorized in accordance with 7.2 - CHANGE ORDER.

6.6 DELAY LIQUIDATED DAMAGES

- 6.6.1 The Contractor acknowledges and agrees that the Owner will suffer financial Loss if the Work is not completed within the time specified in the Agreement. The Contractor also recognizes the delays, costs and difficulties involved in proving the actual Loss suffered by the Owner if the Work is not completed on time. Accordingly, instead of requiring any such proof, the Contractor agrees that if the date of Substantial Performance of the Work is delayed past the Scheduled Date for Substantial Performance of the Work, subject to any adjustment in Contract Time as provided for in the Agreement, the Contractor shall pay Owner liquidated damages in the amount designated in row B.6 of the Information Sheet ("**Delay Liquidated Damages**") for each and every Calendar Day or Working Day, as applicable, of delay until the Contractor has attained Substantial Performance of the Work. The Contractor further expressly acknowledges and agrees that Delay Liquidated Damages payable by the Contractor are:
- .1 not intended to be a penalty and are a reasonable and genuine pre-estimate of the actual damage that will be incurred by the Owner if the Contractor fails to achieve Substantial Performance of the Work in accordance with the requirements of the Agreement (including paragraph 1.3 of Section 1 of the Agreement);

Construction Agreement

Schedule D – General Conditions

- .2 in addition to, and without prejudice to, any other right or remedy available to the Owner under the Agreement or otherwise and does not limit or reduce any obligation or liability of the Contractor under the Agreement or otherwise; and
- .3 not a cap on the damages payable by, or liability of, the Contractor, if the Contractor fails to achieve Substantial Performance of the Work in accordance with the requirements of the Agreement (including paragraph 1.3 of Section 1 of the Agreement).

6.6.2 If there is a delay in attaining Substantial Performance of the Work, in spite of the payment of Delay Liquidated Damages in accordance with GC 7.6.1, the Contractor shall continue to perform and expedite the Work in accordance with the Agreement.

6.6.3 The Contractor shall pay Delay Liquidated Damages pursuant to 7.6.1 on a monthly basis as they accrue.

6.7 CLAIMS PROCEDURE

6.7.1 The Contractor shall provide a Notice in Writing to the Owner and the Contract Administrator of any claim for a change in the Contract Price, extension of the Contract Time or other changes to the Work or amendments to the Agreement (“**Claim Notice**”) within ten (10) Working Days after the Contractor knows, or should know applying the Standard of Care, of the event or circumstance giving rise to such claim. Any Claims by the Contractor in respect of such claim or Claim Notice shall be irrevocably barred, and waived and released by the Contractor unless the Contractor has strictly complied with the applicable requirements of 7.CHANGES IN THE WORK and the Contractor has provided such Claim Notice within the prescribed time period.

6.7.2 Without limiting the generality of any other provision in the Agreement, the Contractor shall immediately upon commencing Work that may result in a Claim Notice, keep such Contractor Records that relate to such Work (including any T&M Change in the Work) and the Claim Notice arising therefrom (including Daily Contractor Work Records) as may be necessary to support and substantiate such Claim Notice. The Contractor shall attempt, on a daily basis, to reconcile its Daily Contractor Work Records with the records of the Contract Administrator or Owner Representative, as applicable and have the Daily Contractor Work Records signed by the Contract Administrator or Owner Representative, as applicable. For clarity, the reconciling of the Contractor’s Daily Work Records with the records of the Contract Administrator or Owner Representative, as applicable, shall not be construed to be acceptance of a Claim Notice. If it is not possible to reconcile the Daily Contractor Work Records, then the Contractor shall submit the un-reconciled Daily Contractor Work Records with its Claim Notice, whereby the resolution of the dispute about the Daily Contractor Work Records shall not be resolved until there is a resolution of the applicable Claim Notice.

6.7.3 Subject to GC 7.7.4, the Claim Notice shall:

- .1 identify the item or items in respect of which the Claim Notice arises;

Construction Agreement

Schedule D – General Conditions

- .2 include the date the Contractor first became aware of the event or circumstance giving rise to the Claim Notice;
- .3 state the grounds, contractual or otherwise, upon which the Claim Notice is made;
- .4 provide sufficient and detailed information and documentation to allow the Contract Administrator and the Owner to properly consider the Claim Notice of the Contractor including:
 - (1) a description of the portions of the Work affected thereby;
 - (2) the cause of the change in the Contract Time, a description of such change, an assessment of the impact such change will have on the Construction Schedule (including an explanation as to how the critical path will be affected) and a reasonable estimate of the number of Calendar Days by which the Work will be delayed and date and time when the delay was experienced;
 - (3) a detailed account of the amount claimed and a breakdown of the change in the Contract Price;
 - (4) details of mitigation strategies applied; and
 - (5) all other pertinent details and backup information and documents; and
- .5 include the Contractor Records (including Daily Contractor Work Records) maintained by the Contractor supporting such Claim Notice.

The Contractor shall submit further updates on the Claim Notice to the Owner and the Contract Administrator as they become available, but in no event shall the Contractor submit any further updates within the fourteen (14) Calendar Days prior to the deadline for the Contract Administrator to issue its determination pursuant to GC 7.7.6.

- 6.7.4 Where the event giving rise to the Claim Notice has a continuing effect, the Claim Notice submitted under GC 7.7.2 shall be considered to be an interim Claim Notice and the Contractor shall, submit further updates on the Claim Notice at such intervals as the Owner or Contract Administrator may reasonably require. Such updates shall give the accumulated amount of the Claim Notice and any further grounds upon which it is based, as a part of the information and documents which the Contractor is required to provide in accordance with GC 7.7.2. The Contractor shall submit a final Claim Notice after the end of the effects resulting from the event as a part of the information and documents which the Contractor is required to provide in accordance with GC 7.7.2.
- 6.7.5 The Contract Administrator may, from time to time, request the Contractor to submit any further and other particulars as the Contract Administrator considers necessary to assess the Claim Notice. The Contractor shall submit the requested information within

Construction Agreement

Schedule D – General Conditions

thirty (30) Calendar Days of receipt of such request or such shorter time as required by the Contract Administrator.

- 6.7.6 Within ninety (90) Calendar Days of initial receipt of the Claim Notice pursuant to GC 7.7.1, or such longer period of time required by Owner, the Owner, or if authorized by the Owner, the Contract Administrator, shall prepare and issue a determination to the Contractor regarding the validity of the Claim Notice. Such determination may be reflected in a Change Order or Change Directive to the extent required pursuant to GC 7.1.2. The Contractor shall be conclusively deemed to have accepted such determination of the Owner, or the Contract Administrator, as the case may be, and to have expressly waived and released the Owner from all Claims in respect of the Claim Notice including the particular matter dealt with in that determination unless, within fifteen (15) Working Days after receipt of that determination, the Contractor provides a revised Claim Notice or disputes that determination in accordance with 12.DISPUTE RESOLUTION.

6.8 SERVICE STANDARDS FOR CONTRACTOR IN RESPONDING TO THIRD PARTY CLAIMANTS

- 6.8.1 For the purposes of this 7.8 - SERVICE STANDARDS FOR CONTRACTOR IN RESPONDING TO THIRD PARTY CLAIMANTS, "Third Party Claimant" means any Person asserting a Claim that is not a party to the Agreement other than a Subcontractor, Supplier or Sub-subcontractor asserting a Claim in respect of the Work or the Project:
- .1 for which such Subcontractor, Supplier or Sub-subcontractor is entitled to assert rights (including lien rights) under the Construction Act against the Owner; or
 - .2 which relate to a Claim the Contractor is asserting against the Indemnitees.
- 6.8.2 Without limiting the obligations of the Contractor under 7.7 – CLAIMS PROCEDURE and GC 7.8.3 or elsewhere in the Agreement, the Contractor shall, or shall cause the Contractor's insurer to, in the manner and extent requested by the Owner:
- .1 respond to all Third Party Claimants in a timely manner;
 - .2 ensure that Third Party Claimants are provided with accurate information about the status of their Claim, and
 - .3 where appropriate, notify Third Party Claimants of the relevant activity on their Claims and provide them with information.
- 6.8.3 If the Contractor receives notice of a Claim of a Third Party Claimant relating to or arising out of the Agreement, the Contractor shall immediately forward the notice of Claim to the City of Toronto Clerk's office at claims@toronto.ca.
- 6.8.4 Once the Contractor receives notice of a Claim of a Third Party Claimant relating to or arising out of the Agreement (including any notice from the City of Toronto's adjuster), the Contractor shall, or shall cause the Contractor's insurer to, in the manner and extent requested by the Owner:

Construction Agreement

Schedule D – General Conditions

- .1 within five (5) Working Days of receiving notice of such Claim, send a letter to the Third Party Claimant acknowledging receipt of such Claim and provide the Third Party Claimant with the contact information of the Contractor Project Manager, or another Person representing the Contractor, to whom the Third Party Claimant can refer questions regarding such Claim;
 - .2 conduct an investigation of such Claim and make a decision regarding such Claim that is based on a proper consideration of the facts; and
 - .3 within twenty-five (25) Working Days of receiving notice of such Claim, provide the Third Party Claimant with a letter advising of the results of the investigation and clearly explaining the Contractor's decision regarding such Claim or should the Contractor require the involvement of their insurance company to resolve such Claim, this shall be forwarded to the insurance company and the Third Party Claimant shall be notified within the allotted period of time above.
- 6.8.5 The Owner may, in writing, provide an extension of time for responding to the Claim of a Third Party Claimant pursuant to this 7.8- SERVICE STANDARDS FOR CONTRACTOR IN RESPONDING TO THIRD PARTY CLAIMANTS if the Contractor or the Contractor's insurer, in writing, provides the Owner with a request for an extension as well as the reasons for the extension. In considering whether to provide such an extension, the Owner shall consider the Contractor's, or the Contractor's insurer's, reasons for the request and all of the surrounding circumstances including good customer service standards. Once the Contractor forwards such Claim to its insurer, the resolution of such Claim shall follow the insurance industry standards for claim investigation.
- 6.8.6 If an extension of time is provided under GC 7.8.5, the Contractor, or the Contractor's insurer, shall write to the Third Party Claimant advising that the investigation is on-going, advise of the date by which the Contractor or its insurer will report the results of the investigation to the Third Party Claimant, and explain the reasons why additional time is required to make a decision on the Claim.
- 6.8.7 A copy of all letters sent to a Third Party Claimant by or on behalf of the Contractor, including letters sent by the Contractor's insurer, pursuant to this 7.8- SERVICE STANDARDS FOR CONTRACTOR IN RESPONDING TO THIRD PARTY CLAIMANTS, shall be copied to the Owner, and the City of Toronto's adjuster.
- 6.8.8 Where appropriate, the Contractor shall ensure its insurer takes all of the appropriate steps to meet the obligations under GC 7.8.1 to 7.8.7.
- 6.8.9 The Contractor shall provide to the Owner monthly updates on the status of all Claims received from Third Party Claimants until resolution of such Claims.
- 6.8.10 If the Contractor fails to meet any of its obligations under this 7.8 - SERVICE STANDARDS FOR CONTRACTOR IN RESPONDING TO THIRD PARTY CLAIMANTS, the Owner may provide the Contractor with Notice in Writing that the relevant obligations have not been fulfilled. If the Contractor does not fulfil such obligations within five (5) Working Days from receipt of such Notice in Writing, the Owner, without prejudice to any other right or remedy, may hold back an amount of

Construction Agreement
Schedule D – General Conditions

\$10,000.00 from monies payable to the Contractor under the Agreement. The Owner may exercise its right of holdback under this section for each Claims of a Third Party Claimant for which the Contractor fails to meet its obligations under 7.8 - SERVICE STANDARDS FOR CONTRACTOR IN RESPONDING TO THIRD PARTY CLAIMANTS. Without limiting any of the Owner's other rights of holdback or set-off, the Owner will release the monies held back pursuant to this GC 7.8.10 once it has received evidence that the Contractor has sent the Third Party Claimant a letter(s) in accordance with GC 7.8.4.1 and 7.8.4.3.

7. INSURANCE, CONTRACT SECURITY, BONDS AND CONTRACTUAL HOLDBACK

7.1 INSURANCE

7.1.1 Without restricting the generality of 9.1 – INDEMNIFICATION or any other provision of the Agreement, the Contractor shall provide, maintain and pay:

- .1 for the insurance coverages listed in this 8.1 - INSURANCE under GCs 8.1.2, 8.1.4, 8.1.5, 8.1.6, 8.1.7, 8.1.8 and 8.1.9 as such coverages may be modified by Row D.1 of the Information Sheet;
- .2 if required by row D.1 of the Information Sheet, coverage under GC 8.1.3; and
- .3 such additional insurance coverages as required by Row D.1 of the Information Sheet.

7.1.2 Commercial General Liability Insurance:

- (1) in the amount of five million dollars (\$5,000,000) per occurrence;
- (2) that includes the Indemnitees and such other Persons identified by the Owner from time to time as additional insureds with respect to liability arising out of the operation of the Contractor with regard to the Agreement; and
- (3) that provides for a cross liability and/or severability of interest, contractual liability, Owner's and Contractor's protective liability, broad form property damage, contingent/and or employer's liability, products and completed operations, non-owned automobile liability and, if applicable to the insured operations as detailed in the Agreement, coverage for blasting, explosion, shoring, underpinning, underground works, pile driving and collapse; and
- (4) which includes completed operations coverage for a period of six (6) years from the date of Substantial Performance of the Work, unless otherwise indicated in the Agreement. If the Contractor fails to comply with the requirements of this GC 8.1.2(4) or to maintain such coverage any contractual period for claiming indemnity described in the Agreement will not be binding on the Owner.

Construction Agreement

Schedule D – General Conditions

7.1.3 Contractor's Pollution Liability Insurance

- .1 If specified in row D.1 of the Information Sheet, pollution liability insurance. The policy shall have a limit of not less than Two Million Dollars (\$2,000,000) per claim limit. The policy shall cover third-party injury and property damage claims, including clean-up costs, as a result of pollution conditions arising from the Contractor's, Subcontractor's, Sub-subcontractor's or Supplier's operations and completed operations (i.e. Work performed). If written as a single project policy, the policy shall include an extended reporting period of 24 months. If written as an annual policy, the policy should be kept in force for 24 months from the date of the later of the: issuance of the Final Acceptance Certificate or termination of the Agreement, as the case may be. The Owner shall be included as an additional insured on this policy.

7.1.4 All Risk Property Insurance

- .1 All risk property insurance shall be written on a replacement cost basis based on the Contract Price, on the building or structure while in the course of construction, and on all Products, Construction Equipment, supplies and/or systems, including boiler and machinery, and pressure vessels if applicable, that form part of the Work or are used in the performance of the Work. The policy may be written separately in the form of a Builder's Risk or Installation Floater; and Boiler and Machinery policy and/or Contractor's Equipment policy, as appropriate to the Project. The Owner shall be included as an additional insured and a joint loss payee on these policies, except for the Contractor's Equipment policy. This GC 8.1.4 is subject to GC 3.14.4.
- .2 The all risk property insurance shall provide that, in the event of a loss or damage:
 - (1) unless directed otherwise by the Owner in its sole and absolute discretion, the Contractor shall act on behalf of both the Owner and the Contractor for the purpose of adjusting the amount of such loss or damage payment with the insurers and payment shall be made to the Owner and the Contractor as their respective interests may appear;
 - (2) when the extent of the loss or damage is determined the Contractor shall proceed to restore the Work. Loss or damage shall not affect the rights and obligations of either party under the Agreement except that the Contract Time may be extended relative to the extent of the loss or damage in accordance with 7.5 – DELAYS; and
 - (3) the Contractor shall be entitled to receive from the Owner, in addition to the amount due under the Agreement, the amount at which the Owner's interest in restoration of the Work has been appraised, such amount to be paid as the restoration of the Work proceeds and in accordance with the requirements of 5. CONTRACT PRICE AND PAYMENT. In addition, the Contractor shall be entitled to receive from the payments made by the insurers the amount of the Contractor's interest in the restoration of the Work.

Construction Agreement

Schedule D – General Conditions

7.1.5 Automobile Liability Insurance

- .1 Automobile liability insurance in respect of all licensed owned/leased vehicles that will be utilized in the performance of the Work, unless otherwise required by the Agreement. Such automobile liability insurance shall have limits of not less than five million dollars (\$5,000,000).

7.1.6 Professional Liability Insurance

- .1 If providing specialized consulting services including architectural, design, mechanical engineering, or other engineering professional services as a part of the Work, the Contractor shall provide and/or cause any Subcontractor or Sub-subcontractor, where such Subcontractor or Sub-subcontractor is under a professional obligation to maintain the same, Professional Liability Insurance or Errors and Omissions Insurance in the amount of not less than five million dollars (\$5,000,000) and shall continue for twenty-four (24) months following the date of the earlier of the issuance of the Final Acceptance Certificate or termination of the Agreement, as the case may be.

7.1.7 Aviation Liability Insurance

- .1 If used directly or indirectly in performance of the Work by the Contractor, Subcontractor, Sub-subcontractor or Supplier, aviation liability insurance with respect to owned or non-owned aircraft, remotely piloted aircraft, unmanned aerial vehicles or drones including the use of additional premises, and shall include, if applicable, coverage for bodily injury, death, aircraft passenger hazard, and damage to property including loss of use thereof. Such insurance shall have limits of not less than five million dollars (\$5,000,000).

7.1.8 Watercraft Liability Insurance

- .1 If used directly or indirectly in performance of the Work by the Contractor, Subcontractor, Sub-subcontractor or Supplier, watercraft liability insurance with respect to owned or non-owned watercraft including the use of additional premises, and shall include coverage for bodily injury, death, and damage to property including loss of use thereof. Such insurance shall have limits of not less than five million dollars (\$5,000,000).

7.1.9 Marine Insurance

- .1 If carrying out any ocean, coastal and inland waterway shipments, the Contractor shall ensure a marine insurance policy is in place to fully insure the full replacement value of the shipment, insurance, and freight plus 10% and should cover the cargo on an "All Risks" basis from the point of origin of shipment until delivery in Toronto, Ontario, including the risk of unloading at the delivery point.
- .2 The Contractor shall maintain or cause to be maintained, if applicable, hull and machinery insurance covering the full replacement cost of all barges, scows and

Construction Agreement
Schedule D – General Conditions

other watercraft owned, rented or leased by the Contractor or any Subcontractor or Sub-subcontractor.

7.1.10 The Contractor shall be responsible for all deductible and self-insured retention amounts under the policies required by this 8.1 - INSURANCE.

7.1.11 Insurance Requirements and Duration

- .1 Unless specified otherwise in this 8.1 - INSURANCE, the duration of each insurance policy shall be from on or before Commencement Date until the date of the earlier of the issuance of the Final Acceptance Certificate or termination of the Agreement, as the case may be.
- .2 Prior to the execution of the Agreement, and upon placement and at amendment or extension of all or any part of the insurance, the Contractor shall within five (5) Working Days provide the Owner with confirmation of coverage on the Owner's certificate of insurance form as attached as Form 2 of Schedule G – Forms or on a form acceptable to the Owner, without notice or demand by the Owner. Prior to the expiration date of all or any part of the insurance the Contractor shall submit to the Owner such confirmation of coverage or a replacement policy without notice or demand by the Owner. The insurance documents required by this GC 8.1.11.2 shall be signed by the insurer or an authorized representative of the insurer.
- .3 If the Owner receives notice of cancellation for nonpayment of the insurance premium, the Owner may, but is not obliged to, pay the premium of any policy of insurance required to be maintained herein and make a formal demand for reimbursement of such costs from the Contractor. If the Contractor fails to pay the cost of the insurance placed by the Owner within fifteen (15) Calendar Days of the date on which the Owner made a formal demand for reimbursement of such costs, the Owner may set-off the costs thereof in accordance with 5.10 – OWNER'S SET-OFF.
- .4 The Contractor shall, on request, within five (5) Working Days provide the Owner with a certified true copy of each insurance policy exclusive of information pertaining to premium or premium bases used by the insurer to determine the cost of the insurance. The certified true copy shall include a signature of the insurer or the underwriter or the broker.
- .5 All insurance policies taken out by the Contractor shall be placed with insurers satisfactory to the Owner in its sole and absolute discretion. Without limiting the generality of the foregoing, all insurers must be licensed to underwrite insurance in the Province of Ontario, except to the extent the Owner waives such requirement in writing.
- .6 The insurance policies required pursuant to this GC shall:
 - (1) be primary and shall not call into contribution any insurance available to the Owner; and

Construction Agreement
Schedule D – General Conditions

- (2) contain a waiver of subrogation rights which the insurers may have against the Owner or any other additional insured, except for the Automobile Liability and Professional Liability policies.
- .7 The amount of the deductible for the purpose of the Agreement shall not be more than \$25,000.00. Following the award of the Agreement, the Owner reserves the right to negotiate a higher or lower deductible, as appropriate.
- .8 In addition to the insurance required by 8.1 – INSURANCE, the Contractor shall, at its cost, maintain such other forms of insurance as the Owner, acting reasonably, may require from time to time, in amounts and for risks against which a prudent contractor would insure.
- .9 Each policy (except for the policy of automobile liability insurance required under GC 8.1.5) shall contain an endorsement requiring the insurer(s) to notify the Owner in writing, by registered mail, at least thirty (30) Calendar Days (fifteen (15) Calendar Days if cancellation is due to non-payment of premium), prior to any cancellation of the Contractor's insurance.
- .10 "Claims made" insurance policies shall not be permitted, except for the Professional Liability and Contractor's Pollution Liability policy.
- .11 The insurance coverages required by 8.1 – INSURANCE shall allow for partial or total use and occupancy by the Owner prior to Substantial Performance of the Work in accordance with 3.14.
- 7.1.12 The Contractor shall cause the Subcontractors and Suppliers to provide and maintain, at the expense of the Subcontractors and Suppliers, the insurance set out in GC 8.1.3 and 8.1.5.

7.2 CONTRACT SECURITY

- 7.2.1 The Contractor shall, prior to the Commencement Date or within the specified time, provide to the Owner any contract security specified in row D.2 of the Information Sheet.

7.3 SURETY BONDS

- 7.3.1 Unless expressly indicated otherwise in row D.5 of the Information Sheet, the Contractor shall provide surety bonds, which shall be:
 - .1 a performance bond with a coverage limit of fifty percent (50%) of the aggregate amount of the Fixed Price and the estimated Total Price of Unit Price Work (calculated using the Estimate of Units for Completion), plus Value Added Taxes; and a labour and material payment bond with a coverage limit of fifty percent (50%) of such aggregate amount;
 - .2 in compliance with the requirements of the Construction Act and in the form prescribed by the Construction Act; and

Construction Agreement

Schedule D – General Conditions

.3 delivered to the Owner prior to the execution of the Agreement by both the Owner and the Contractor.

7.3.2 The premiums for the bonds required by the Agreement are included in the Fixed Price and Unit Prices.

7.3.3 If the Contract Price increases during the Performance of the Work, the Owner shall have the right, in its sole discretion and at any time, to require riders be provided to the existing bonds, to increase the value of the bonds to fifty percent (50%) of the total of the Contract Price plus Value Added Taxes.

7.4 CONTRACTUAL HOLDBACK

7.4.1 The Owner shall retain a contractual holdback equal to the amount(s) identified in row D.3 of the Information Sheet (the aggregate of such amounts retained by the Owner being the “**Contractual Holdback**”). For clarity, the Owner shall not retain Contractual Holdback in respect of the payment of Lien Holdback pursuant to 5.6 - PAYMENT OF LIEN HOLDBACK UPON SUBSTANTIAL PERFORMANCE OF THE WORK or the payments pursuant to 5.7 – PAYMENTS UPON TOTAL PERFORMANCE OF THE WORK.

7.4.2 The Owner, without prejudice to any other right or remedy, shall be entitled to apply the Contractual Holdback towards Losses the Owner may suffer, sustain or incur in connection with the:

- .1 exercise of its rights in respect of the Contractor’s failure to correct a default pursuant to GC 11.1.5;
- .2 failure of Contractor to complete the Work and correct deficient Work after the issuance of the certificate of Substantial Performance of the Work in accordance with the completion schedule established pursuant to GC 5.5.3; and
- .3 exercise of its right to correct Deficiencies or make good damaged work or property pursuant to GC 2.5.4 and 9.3.5.

7.4.3 Upon the Total Performance of the Work, the portion of the Contractual Holdback which remains after the Owner has exercised its rights pursuant to 8.4.2, if any, shall be reduced by the percentage amount identified in row D.4 of the Information Sheet. The reduced amount of the Contractual Holdback (without any interest owed by the Owner) shall be eligible to be included in the Proper Invoice submitted pursuant to GC 5.7.1.1.

7.4.4 After the issuance of the Final Acceptance Certificate, the Contractor may submit a Proper Invoice to the Owner in accordance with the applicable requirements of 5.3 – PROPER INVOICES requesting release of the portion of the Contractual Holdback which remains after the Owner has exercised its rights pursuant to GC 8.4.2, if any. The Owner shall make payment to the Contractor of such remaining portion of the Contractual Holdback (without any interest owed by the Owner) in accordance with the applicable requirements of 5.4 – PROGRESS PAYMENT.

8. INDEMNIFICATION, WAIVER OF CLAIMS AND WARRANTY

8.1 INDEMNIFICATION

8.1.1 The Contractor shall indemnify, defend and hold harmless the Owner, the mayor of the City of Toronto and each of the City of Toronto’s agencies, boards, commissions, Personnel, elected officials, servants, volunteers and advisers (including the Contract Administrator and the Owner Representative), and their respective successors and assigns (collectively as the “**Indemnitees**”) from and against all Claims brought against, or Losses suffered, sustained, or incurred by, the Indemnitees which may be directly or indirectly attributable to, or arising or alleged to arise out of:

- .1 the negligent acts or omissions of the Contractor Parties;
- .2 any deliberate act of wrongdoing or wilful misconduct or fraud of a Contractor Party including intentional misrepresentation; or
- .3 the performance of or the failure to perform any of the Contractor’s obligations under the Agreement

(collectively, the “**Subject Matter of Indemnity**”). The Subject Matter of Indemnity includes:

- .4 all Losses that any of the Indemnitees may suffer, sustain or incur arising in respect of bodily injury, illness or death of any individual or physical loss of or damage to tangible property (including all or any part of the Site or any other tangible property related thereto); and
- .5 all Claims arising in respect of bodily injury, illness or death of any individual or physical loss of or damage to tangible property.

8.1.2 Without limiting the generality of any other provision in the Agreement, the Contractor shall indemnify, defend and hold harmless the Indemnitees from and against all Claims brought against, or Losses suffered, sustained, or incurred by the Indemnitees which may be directly or indirectly attributable to, or arising or alleged to arise out of:

- .1 a lien or subsequent lawsuit brought in connection with any lien by a Subcontractor, Sub-subcontractor or Supplier;
- .2 the infringement or an alleged infringement of any patented invention or copyright by the Contractor Parties in connection with the Work including the Products;
- .3 the Contractor’s failure to comply with the requirements of 4.3 – HAZARDOUS MATERIALS;
- .4 the Contractor’s failure to comply with the requirements of OHSA and the duties, responsibilities and obligations of the constructor under OHSA;
- .5 the Contractor’s failure to comply with the requirements of GC 12.2.16 or 3.8.2.3(3);

Construction Agreement

Schedule D – General Conditions

- .6 a Subcontractor, Supplier or Sub-subcontractor's failure to comply with the requirements of GC 3.8.2.3(3);
 - .7 the presence of mould caused by the Contractor's operations under the Agreement as determined in accordance with GC 4.4.2; or
 - .8 the Contractor's failure to comply with the requirements of GC 10.1.6.
- 8.1.3 The Contractor shall pay to the Indemnitees, or any of them, on demand the amount of all Losses and Claims for which the Contractor is obligated to indemnify the Indemnitees and any moneys paid or payable by the Indemnitees in settlement or in discharge or on account thereof. If the Contractor fails to make such payments within ten (10) Working Days after such demand, the Owner may set-off such payments in accordance with 5.10 – OWNER'S SET-OFF.
- 8.1.4 The Owner shall indemnify, defend and hold harmless the Contractor from and against all Claims brought against the Contractor by third parties, or Losses suffered, sustained, or incurred by the Contractor in respect of such third party Claims, that are attributable to, or arise out of, the Contractor's direct involvement in the Agreement, provided such third party Claims are directly caused by the negligent act or omission of the Owner in the performance of the Owner's obligations under the Agreement, and then only to the extent the Losses was caused by the Owner.
- 8.1.5 The Owner shall indemnify, defend and hold harmless the Contractor from and against all Claims brought against the Contractor, or Losses suffered, sustained, or incurred by the Contractor arising out of the Contractor's performance of its obligations under the Agreement which are attributable to, or arise out of
- .1 a lack of or defect in title or an alleged lack of or defect in title to the Site; or
 - .2 an infringement of a patent of invention directly resulting from the use of a model, plan or design that was supplied to the Contractor by the Owner as part of the Agreement,
- but excluding any consequential, indirect or special damages and loss of profit, loss of opportunity or loss of productivity. The Contractor expressly waives the right to indemnity for Claims other than those stated above.
- 8.1.6 The Contractor hereby authorizes and empowers the Owner or its solicitor to defend, settle or compromise any of the Claims described in GC 9.1.1 and 9.1.2 as the Owner or its solicitor may deem expedient. The Contractor shall ratify and confirm all the acts of the Owner and its solicitor undertaken pursuant to this GC 9.1.6 and shall pay to such solicitor on demand his or her reasonable costs of any such defense, settlement and/or compromise. If the Contractor fails to make such payments to the solicitor, the Owner may set-off such payments in accordance with 5.10 – OWNER'S SET-OFF.
- 8.1.7 The Contractor shall not settle or compromise any of the Claims described in GC 9.1.1 or 9.1.2, for which it is liable to indemnify, defend and hold harmless the Owner without first obtaining the consent of the Owner with such consent not to be unreasonably withheld or delayed.

Construction Agreement

Schedule D – General Conditions

- 8.1.8 The Contractor acknowledges that the Owner holds the benefit of any covenant, release or indemnity in the Agreement, including the covenants of the Contractor in GC 9.1.1, 9.1.2 and 9.1.3, that is expressly intended to extend to include the Indemnitees (other than the Owner) as third party beneficiaries as trustee and agent for such Indemnitees. The Owner shall be entitled to enforce the rights of such Indemnitees as third party beneficiaries under such covenant and indemnities.
- 8.1.9 9.1 - INDEMNIFICATION in no way limits any other liability or obligation of the parties in respect of the Agreement.

8.2 WAIVER OF CLAIMS

- 8.2.1 With its Proper Invoice for the Lien Holdback submitted in accordance with 5.6 - PAYMENT OF LIEN HOLDBACK UPON SUBSTANTIAL PERFORMANCE OF THE WORK, the Contractor shall include a list setting out the status of all outstanding Claim Notices which have been submitted in strict compliance with 7.7 – CLAIMS PROCEDURE. For clarity, notwithstanding any other provision of the Agreement to the contrary:
- .1 any Claim Notices submitted prior to such Proper Invoice, but which are not set out in such list shall be deemed to be irrevocably barred, and waived and released by Contractor; and
 - .2 any Claims not included in such list shall be deemed to be irrevocably and unconditionally barred, and waived and released by Contractor, except for payment of the Lien Holdback which is the subject matter of such Proper Invoice, payment of the Contractual Holdback and any Claims in respect of Work to be performed sixty (60) Days prior to the date of Substantial Performance and on and after the date of Substantial Performance of the Work.
- 8.2.2 With its Proper Invoice submitted pursuant to GC 5.7.1.1 the Contractor shall include a list setting out the status of all outstanding Claim Notices which have been submitted in strict compliance with 7.7 – CLAIMS PROCEDURE. For clarity, notwithstanding any other provision of the Agreement to the contrary:
- .1 any Claim Notices submitted prior to such Proper Invoice, but which are not set out in such list shall be deemed to be irrevocably barred, and waived and released by Contractor; and
 - .2 any Claims not included in such list shall be deemed to be irrevocably and unconditionally barred, and waived and released by Contractor, except for payment of any remaining Lien Holdback and the payment which is the subject matter of such Proper Invoice.

8.3 WARRANTY

- 8.3.1 The Contractor warrants that all Work shall be free of Deficiencies including in materials and workmanship and conform to the requirements of the Agreement during the Warranty Period. Except as expressly provided elsewhere in the Agreement, the Contractor does not warrant that the Owner Supplied Materials are free of

Construction Agreement

Schedule D – General Conditions

- Deficiencies. For clarity, this does not limit any warranty obligations of the Contractor for Work in respect of, or in connection with, the Owner Supplied Materials.
- 8.3.2 The Owner or Contract Administrator shall promptly give the Contractor Notice in Writing of observed Deficiencies which occur during the Warranty Period.
- 8.3.3 The Contractor shall, at the Contractor's cost, commence correction of Deficiencies in the Work which appear prior to and during the Warranty Period promptly, and in no event later than within ten (10) Working Days after receipt of Notice in Writing from the Owner or Contract Administrator of observed Deficiencies, and promptly complete the correction of such Deficiencies. The obligation of the Contractor to perform the corrective Work in accordance with this 9.3 – WARRANTY shall include the provision of all necessary labour and materials and the removal and replacement of covering materials. The carrying out of the correction of Deficiencies shall be executed at times convenient with the Owner which may entail overtime Work on the part of, and at the cost of, the Contractor. For greater certainty, if the Contractor is notified of Deficiencies prior to the end of the Warranty Period, then the Contractor shall make good the Deficiencies, notwithstanding that the warranty Work may commence or extend beyond the end of the Warranty Period.
- 8.3.4 The Contractor shall, at its cost, make good or pay for damage or destruction to other parts of the Work, the Owner's or other contractors' property or any other property caused by the Deficiencies during the Warranty Period or the correction of such Deficiencies.
- 8.3.5 If after receipt of the Owner's or Contract Administrator's Notice in Writing, the Contractor fails to, within the required period, commence and complete the correction of Deficiencies or make good damage or destruction to other parts of the Work, the Owner's or other contractors' property or any other property as required by this 9.3 – WARRANTY, the Owner may correct the Deficiencies or make good such damage and destruction and hold the Contractor responsible for all costs thereof.
- 8.3.6 Any extension of the warranty beyond the Warranty Period shall be as specified in the Agreement ("**Extended Warranty Periods**"). Without limiting the Contractor's warranty under 9.3 – WARRANTY, the Extended Warranty Periods shall be issued by the warrantor to the benefit of the Owner. The Contractor's responsibility with respect to the Extended Warranty Periods shall be limited to obtaining any of the Extended Warranty Periods from the warrantor and assisting the Owner in the administration of the Extended Warranty Periods to the extent reasonably required by the Owner. The obligations under the Extended Warranty Periods are solely the responsibilities of the warrantor. For clarity, this GC 9.3.6 does not limit any responsibility or liability of the Contractor in respect of Deficiencies which appear prior to and during the Warranty Period.
- 8.3.7 Any Product or equipment requiring excessive servicing during the Warranty Period (or free maintenance period, if applicable) shall be considered Deficient and the warranty (or free maintenance period) shall be deemed to take effect from the time that the Deficiency has been corrected so as to cause excessive servicing to terminate.

Construction Agreement

Schedule D – General Conditions

- 8.3.8 Within thirty (30) Calendar Days after Substantial Performance of the Work, and without limiting the Contractor's warranty under this 9.3 – WARRANTY, the Contractor shall assign to the Owner, to the extent assignable, the benefit of all warranties and guarantees relating to the Work. The assignment shall:
- .1 expressly reserve the right of the Contractor to make any claims under such warranties and guarantees;
 - .2 in no way prejudice any rights of or benefits accruing to the Contractor pursuant to such warranties and guarantees; and
 - .3 be in a form acceptable to the Owner.
- 8.3.9 The provisions of 9.3 – WARRANTY shall not deprive the Owner of any action, right or remedy otherwise available to the Owner for the Contractor's failure to fulfill its obligations or responsibilities under the Agreement and shall not be construed as a waiver of Claims in favour of the Contractor or as a limitation on the time in which the Owner may pursue such other action, right or remedy. The warranties set out in the Agreement are not supplemental to and do not limit or preclude the application of any other conditions and warranties, express or implied, by law, trade usage or otherwise.
- 9. GOVERNING REGULATIONS**
- 9.1 LAWS, NOTICES, PERMITS, AND FEES**
- 9.1.1 The Owner shall obtain and pay for development approvals, building permit, easements, rights of servitude, and all other necessary approvals and permits, except for the permits and fees referred to in GC 10.1.2 or for which the Agreement specify as the responsibility of the Contractor.
- 9.1.2 The Contractor shall be responsible for the procurement of permits, licences, inspections, and certificates, which are necessary for the performance of the Work (including dewatering permits/agreements) and customarily obtained by contractors in the jurisdiction of the Site after the issuance of the building permit. The Contract Price includes the cost of these permits, licences, inspections, certificates and agreements, and their procurement.
- 9.1.3 The Contractor shall, and shall cause all Subcontractors, Suppliers and Sub-subcontractors to give the notices required by, and comply with, the Laws which are or come into force during the performance of the Work and which relate to the Work, to the preservation of health and safety.
- 9.1.4 Without limiting GC 10.1.3, the Contractor shall notify the Chief Building Official or the registered code agency where applicable, of the readiness, substantial completion, and completion of the stages of construction set out in the Ontario Building Code. The Contractor shall be present at each site inspection by an inspector or registered code agency as applicable under the Ontario Building Code.
- 9.1.5 Subject to 3.6 – DOCUMENT REVIEW AND EXAMINATION OF SITE, the Contractor shall not be responsible for verifying that the Agreement is in compliance with the

Construction Agreement
Schedule D – General Conditions

Laws relating to the Work. If the Agreement is at variance therewith, or if, subsequent to the Effective Date, changes are made to the applicable Laws which require modification to the Agreement, the Contractor shall advise the Contract Administrator in writing requesting direction immediately upon such variance or change becoming known. The Contract Administrator will make the changes required to the Agreement as provided in 7.1 - OWNER'S RIGHT TO MAKE CHANGES, 7.2 - CHANGE ORDER and 7.3 - CHANGE DIRECTIVE.

9.1.6 If the Contractor:

- .1 fails to notify the Owner and the Contract Administrator in writing of changes made to the applicable Laws (other than Owner's Policies, Procedures and By-laws) in accordance with GC 10.1.5;
- .2 fails to obtain direction as required in GC 10.1.5; or
- .3 performs Work that it knows or should have known, applying the Standard of Care, contravenes any Laws,

the Contractor shall be responsible for and shall correct the violations of such Laws, and shall be responsible for the Losses and delay attributable to the failure to comply with the provisions of such Laws, and, notwithstanding any limitations described in GC 9.1.1.

9.1.7 Notwithstanding GC 7.5.2, if subsequent to the Effective Date, changes are made to Laws (other than Owner's Policies, Procedures and By-laws) which increase or decrease the cost of the performance of the Work or Contract Time then:

- .1 any claim by the Contractor must be submitted in accordance with the requirements of 7.7 - CLAIMS PROCEDURE; and
- .2 the Owner may submit a change in accordance with the requirements of 7.1 – OWNER'S RIGHT TO MAKE CHANGES.

9.1.8 Without limiting the generality of any other provision in the Agreement, the Contractor shall cause all certificates to be furnished that are required or given by the appropriate Governmental Authorities or quasi-governmental authorities as evidence that the Work as installed conforms with the Laws, including certificates of compliance for the Owner's occupancy or partial occupancy. The certificates are to be final certificates giving complete clearance of the Work, in the event that such Governmental Authorities or quasi-governmental authorities furnish such certificates.

9.2 TAXES AND DUTIES

9.2.1 Subject to GC 10.2.3, the Fixed Prices and Unit Prices shall include all taxes and customs duties except for Value Added Taxes payable by the Owner to the

Construction Agreement

Schedule D – General Conditions

Contractor. For clarity, there shall be no adjustment in the Fixed Price or Unit Prices as a result of inflation or currency fluctuation.

- 9.2.2 The Contractor shall provide a detailed breakdown of additional taxes and duties if requested by the Owner in a form satisfactory to the Owner.
- 9.2.3 Any increase or decrease in costs to the Contractor due to changes in Canadian federal and provincial taxes and custom duties after the Effective Date shall increase or decrease the Fixed Prices and Unit Prices accordingly. For greater certainty, the Contractor shall not be entitled to any markup for overhead or profit on any increase in such taxes and duties.
- 9.2.4 The Contractor represents and warrants that it is:
- .1 not a non-resident Canadian; or
 - .2 has notified the Owner in writing, prior to execution of the Agreement that it is a non-resident Canadian,
- for the purposes of the *Income Tax Act* (Canada). Notwithstanding anything to the contrary, all amounts payable by the Owner shall be subject to the *Income Tax Act* (Canada) (including applicable deductions from payments by the Owner on account of withholding against tax). Without limiting the generality of the foregoing, if any Laws requires that any taxes or other amounts be deducted or withheld from any payments to be made by the Owner under the Agreement, the Owner shall deduct such taxes or other amounts and remit such taxes or other amounts directly to the applicable Governmental Authority, including the Canada Revenue Agency, on or before the applicable due date and the Owner shall not be required to compensate or otherwise indemnify the Contractor with respect to such taxes or other amount.
- 9.2.5 Any taxes or customs duties applicable to the Agreement, including any sales taxes, excise taxes or Value Added Taxes, whether or not paid, which are found to be inapplicable or for which refund, exemption or recovery may be obtained, are the sole and exclusive property of the Owner. The Contractor agrees to, and to cause all Subcontractors, Suppliers and Sub-subcontractors to, cooperate with the Owner in the application for any refund, exemption or recovery of any taxes or customs duties, which cooperation shall include, making or concurring in the making of an application for any such refund, exemption or recovery, and providing to the Owner copies, or where required, originals of Contractor Records or other documents necessary to support such applications for refunds, exemptions or recoveries. All such refunds, exemptions or recoveries shall either be paid to the Owner, or shall be a credit to the Owner against the Contract Price in accordance with 5.10 – OWNER’S SET-OFF, in the Owner’s discretion. The Contractor agrees to endorse over to the Owner any cheques received from the federal or provincial governments, or any other taxing authority, as may be required to give effect to this GC. The Contractor agrees to enable, assist with and submit to any reasonable audit requested by the Owner with respect the potential refunds, exemptions or recoveries under this GC.

Construction Agreement

Schedule D – General Conditions

9.2.6 Customs duties penalties, or any other penalty, fine or assessment levied against the Contractor, shall not be treated as a tax or customs duty for the purpose of this 10.2 – TAXES AND DUTIES.

9.3 PATENT FEES

9.3.1 The Contractor shall pay the royalties and patent licence fees required for the performance of the Agreement.

9.4 WORKERS' COMPENSATION

9.4.1 Prior to commencing the Work, and again with the Proper Invoice for the Lien Holdback following Substantial Performance of the Work and the Contractor's Proper Invoice submitted pursuant to GC 5.7.1.1, the Contractor shall provide evidence of compliance with workers' compensation Laws, including payments due thereunder by the Contractor.

9.4.2 At any time during the term of the Agreement, when requested by the Owner, the Contractor shall provide evidence of compliance with workers' compensation Laws by the Contractor and Subcontractors.

10. DEFAULT, TERMINATION AND SUSPENSION

10.1 OWNER'S RIGHT TO PERFORM THE WORK, TERMINATE THE CONTRACTOR'S RIGHT TO CONTINUE WITH THE WORK, TERMINATE THE AGREEMENT OR SUSPEND THE WORK

10.1.1 If the Contractor is adjudged bankrupt, or makes a general assignment for the benefit of creditors because of the Contractor's insolvency, or if a receiver is appointed because of the Contractor's insolvency, the Owner may, without prejudice to any other right or remedy the Owner may have, immediately terminate the Contractor's right to continue with the Work or immediately terminate the Agreement, by giving the Contractor or receiver or trustee in bankruptcy Notice in Writing to that effect specifying the date upon which such termination becomes effective.

10.1.2 If the Contractor:

- .1 fails to comply with the requirements of 1.7 – CONFLICTS OF INTEREST or if the parties are unable to resolve a Conflict of Interest of the Contractor to the satisfaction of the Owner;
- .2 fails to provide a Recovery Plan in accordance with GC 7.5.6.1 or comply with the requirements in respect of a Recovery Plan under GC 7.5.6.2 and 7.5.6.3; or
- .3 is found or determined to have committed any offence that qualifies as an "indictable offence" under the *Criminal Code* (Canada) or any offence of a similar nature with substantially similar penalties under any quasi-criminal provisions of another Law or any fraudulent act in any way related to the Work or the Agreement,

Construction Agreement
Schedule D – General Conditions

the Owner may, without prejudice to any other right or remedy the Owner may have, immediately terminate the Contractor's right to continue with the Work or immediately terminate the Agreement, by giving the Contractor Notice in Writing to that effect specifying the date upon which such termination becomes effective.

10.1.3 Subject to GC 11.1.1 and GC 11.1.2, if the Contractor:

- .1 fails to commence the Work by the Commencement Date;
- .2 neglects to prosecute the Work properly or fails or neglects to maintain the latest Construction Schedule; or
- .3 otherwise fails to comply with the requirements of the Agreement,

the Owner may, without prejudice to any other right or remedy the Owner may have, give the Contractor Notice in Writing that the Contractor is in default of the Contractor's contractual obligations and instruct the Contractor to correct the default in the five (5) Working Days immediately following the receipt of such Notice in Writing. Failure by the Owner to provide such Notice in Writing in a timely manner after the default has occurred shall not constitute condonation of the default.

10.1.4 If the Owner determines that the default referred to in GC 11.1.3 cannot be corrected in the five (5) Working Days specified or in such other time period as may be subsequently agreed in writing by the parties, the Contractor shall be in compliance with the Owner's instructions if the Contractor:

- .1 commences the correction of the default within the specified time;
- .2 provides the Owner with an acceptable schedule for such correction; and
- .3 corrects the default in accordance with the Agreement terms and with such schedule.

10.1.5 If the Contractor fails to correct the default referred to in GC 11.1.3 in the time specified or in such other time period as may be subsequently agreed in writing by the parties, without prejudice to any other right or remedy the Owner may have, the Owner may:

- .1 correct such default and set-off the cost thereof in accordance with 5.10 – OWNER'S SET-OFF provided the Contract Administrator has certified such cost to the Owner and the Contractor;
- .2 charge the Contractor for any Losses suffered, sustained or incurred by the Owner as a result of such default and/or set-off such Losses in accordance with 5.10 – OWNER'S SET-OFF; or
- .3 immediately terminate the Contractor's right to continue with the Work in whole or in part or immediately terminate the Agreement by giving the Contractor Notice in Writing to that effect specifying the date upon which such termination becomes effective.

Construction Agreement

Schedule D – General Conditions

- 10.1.6 If the Owner terminates the Contractor's right to continue with the Work or terminates the Agreement as provided in GC 11.1.1, 11.1.2 and 11.1.5, without prejudice to any other right or remedy which the Owner may have, the Owner may, at its sole option:
- .1 take possession of the Work, Products and Owner Supplied Material at the Site;
 - .2 subject to the rights of third parties, utilize the Construction Equipment at the Site;
 - .3 finish the Work by whatever method the Owner may consider expedient, but without undue delay or cost;
 - .4 require Contractor to provide such reasonable assistance as required to properly and safely transition the Work to the Owner or its other contractors;
 - .5 withhold further payment to the Contractor until a final certificate for payment is issued;
 - .6 charge the Contractor the amount by which the full cost of finishing:
 - (1) any Fixed Price Work as certified by the Contract Administrator exceeds the unpaid balance of the Fixed Price; and
 - (2) any Unit Price Work as certified by the Contract Administrator exceeds the portion of the Total Price of Unit Price Work that would have been paid to the Contractor on the completion of such Unit Price Work (calculated based on the number of units required to complete the Unit Price Work after the effective date of termination).plus compensation to the Contract Administrator for the Contract Administrator's additional services and a reasonable allowance as determined by the Contract Administrator to cover the cost of corrections to Work performed by the Contractor that may be required under 9.3 - WARRANTY;
 - .7 on expiry of the Warranty Period, charge the Contractor the amount by which the cost of corrections to the Contractor's Work under 9.3 - WARRANTY exceeds the allowance provided for such corrections, or if the cost of such corrections is less than the allowance, pay the Contractor the difference; and
 - .8 charge the Contractor for any Losses suffered, sustained or incurred by the Owner as a result of such termination and/or set-off such Losses in accordance with 5.10 – OWNER'S SET-OFF.

For clarity, any one or more of the Owner's rights in GC 11.1.6 shall also apply to the portions of the Work that the Owner has terminated the Contractor's right to continue pursuant to GC 11.1.5.3, *mutatis mutandis*.

- 10.1.7 Upon receipt of Notice in Writing from the Owner terminating the Agreement, the Contractor shall:

Construction Agreement

Schedule D – General Conditions

- .1 subject to GC 11.1.6.4, cease Work on the effective date of the termination;
- .2 place no additional orders (and if requested by the Owner, the Contractor shall cancel existing orders and subcontracts specified by the Owner upon terms satisfactory to the Owner); and
- .3 preserve and protect the Products (at the Site or in transit), Owner Supplied Material and Work completed and in progress pending the Owner's instructions, and the Contractor shall dispose of same in accordance with the Owner's instructions.

10.1.8 The Contractor's obligation under the Agreement as to quality, correction and warranty of the Work performed by the Contractor up to the time of termination shall continue after such termination of the Agreement.

10.1.9 Termination for Convenience

- .1 Notwithstanding any other term or condition in the Agreement, the Owner may (at any time) terminate the Contractor's right to continue with the Work or terminate the Agreement without cause and in its sole and absolute discretion by giving a Notice in Writing to the Contractor, specifying the date upon which such termination becomes effective, provided that such termination date may not be less than seven (7) Calendar Days from the date on which the Contractor is deemed to have received such Notice in Writing.
- .2 In the event of termination pursuant to GC 11.1.9.1, the Owner shall be entitled to take possession of the Site, the Work, the Products and the Owner Supplied Material, and the Contractor shall be entitled to be paid for the following, without duplication, but subject to the other requirements in the Agreement to be satisfied by the Contractor prior to payment:
 - (1) the value proportionate to the Contract Price, of the Work performed up to the effective date of termination;
 - (2) reasonable demobilization costs paid by the Contractor which have been pre-approved by the Owner in writing;
 - (3) reasonable costs incurred in connection with the preservation or protection of the Work; and
 - (4) Subcontractor and Supplier cancellation costs reasonably paid by the Contractor as a result of such termination which have been pre-approved by the Owner in writing and could not have been reasonably mitigated by the Contractor.

For greater certainty, the amounts payable pursuant to GC 11.1.9.2(1) are less any previous amounts paid or properly withheld on account of the Contract Price and except for the amounts referred to in this GC 11.1.9.2, the Contractor shall not be entitled to any additional Losses resulting from the termination in

Construction Agreement

Schedule D – General Conditions

accordance with GC 11.1.9.1 including any consequential, indirect or special damages and loss of profit, loss of opportunity or loss of productivity.

10.1.10 Notwithstanding any other provision in the Agreement, the Contractor shall accept, and not dispute, the termination of the Agreement or the Contractor's right to continue with the Work in whole or in part by the Owner under GC 11.1.1, 11.1.2 or 11.1.5.3, provided that the Contractor is entitled to dispute the existence of the underlying default or event giving the Owner the right to terminate the Agreement, or the Contractor's right to continue with the Work in whole or in part, in accordance with 12. DISPUTE RESOLUTION. However, if the Agreement is terminated under GC 11.1.1, 11.1.2 or 11.1.5.3 and it is later determined that there was no default or other event giving the Owner the right to terminate the Agreement or the Contractor's right to continue with the Work in whole or in part, as applicable, such termination shall be deemed to have been a termination for convenience and the rights and obligations of GC 11.1.9 shall apply to such termination.

10.1.11 Suspension

- .1 The Owner, from time to time, may suspend any portion or the whole of the Work for any reason for such time as the Owner may notify the Contractor in a Notice in Writing. In addition to suspending any portion or the whole of the Work, the Owner shall be entitled to instruct the Contractor in the Notice in Writing to take such other action as may be reasonably required in respect of the suspension.
- .2 The Contractor shall, upon receipt of such Notice in Writing, suspend the Work referred to in such Notice in Writing (except for Work which, in the reasonable opinion of the Contractor is necessary for the safety and security of people or property) and such suspended Work shall not be resumed until the Owner so directs in writing.
- .3 Subject to GC 2.2.19, upon resumption of the suspended Work and provided the suspension of the Work was not as a result of the negligent act or omission of the Contractor Parties or the default or breach of the Contractor's obligations under the Agreement or any other act or fault of the Contractor Parties, the Contract Time shall be extended for such reasonable time as agreed to by the Parties, taking into account such time period as recommended by the Contract Administrator and the Contract Price shall be adjusted to account for reasonable Losses incurred by the Contractor as the result of such suspension but excluding any consequential, indirect or special damages and loss of profit, loss of opportunity or loss of productivity resulting from such suspension.

10.1.12 The Contractor acknowledges that remedies at law may be inadequate to provide the Owner with full compensation if the Contractor breaches its obligations under this 11.1 - OWNER'S RIGHT TO PERFORM THE WORK, TERMINATE THE CONTRACTOR'S RIGHT TO CONTINUE WITH THE WORK, TERMINATE THE CONTRACT OR SUSPEND THE WORK and that any such breach of such obligations by the Contractor may cause the Owner irreparable harm. As a result, the Owner will be entitled, without prejudice to any other right or remedy it may have at law or in equity, to seek injunctive relief, specific performance, or any other equitable

Construction Agreement
Schedule D – General Conditions

remedy if the Contractor breaches such obligations or takes steps that reasonably will result in a breach of such obligations.

10.2 CONTRACTOR'S RIGHT TO TERMINATE THE AGREEMENT

10.2.1 If the Work is suspended or otherwise delayed for a period of sixty (60) Working Days (or such alternate period under row C.11 of the Information Sheet) or more, by a stop work order issued by a court or other public authority (other than the City of Toronto) and providing that such order was not issued as the result of an act or fault of a Contractor Party, the Contractor may terminate the Agreement by giving the Owner Notice in Writing to that effect specifying the date upon which such termination becomes effective.

10.2.2 The Contractor may give Notice in Writing to the Owner, with a copy to the Contract Administrator, that the Owner is in default of the Owner's contractual obligations if:

- .1 the Contract Administrator fails to issue a certificate for payment as provided in 5.4 - PROGRESS PAYMENT; or
- .2 the Owner fails to pay the Contractor an amount: (1) which is due and payable under the Agreement, subject to the Owner's right to set-off pursuant to 5.10 – OWNER'S SET-OFF; or (2) awarded by arbitration or court; or
- .3 the Owner fails to comply with a material requirement of the Agreement,

and instruct the Owner to correct the default in the fifteen (15) Working Days immediately following the receipt of such Notice in Writing.

10.2.3 If the default cannot be corrected within the fifteen (15) Working Days specified in GC 11.2.2, the Owner shall be in compliance with the Contractor's instructions if the Owner:

- .1 commences the correction of the default within the specified time;
- .2 provides the Contractor with an acceptable schedule for such correction; and
- .3 completes the correction in accordance with such schedule.

10.2.4 If the Owner fails to correct the default in the time specified or subsequently agreed upon, the Contractor may, without prejudice to any other right or remedy the Contractor may have, terminate the Agreement by giving the Owner Notice in Writing to that effect specifying the date upon which such termination becomes effective.

10.2.5 If the Contractor terminates the Agreement under the conditions described in this 11.2 - CONTRACTOR'S RIGHT TO TERMINATE THE AGREEMENT, the Contractor shall be entitled to be paid for all Work performed to the date of termination. The Contractor shall also be entitled to recover the reasonable Losses associated with termination, including the costs of demobilization, but excluding any consequential, indirect or special damages and loss of profit, loss of opportunity or loss of productivity resulting from such termination.

10.3 OTHER TERMINATION OBLIGATIONS

- 10.3.1 If the Agreement is terminated, by the Owner or Contractor, as the case may be:
- .1 the party terminating the Agreement shall publish, in the manner set out in the Construction Act, a notice of the termination in the form prescribed by the Construction Act and, for the purposes of this section, the date on which the Agreement is terminated is the termination date specified in the Notice in Writing delivered by such party to the other party pursuant to the Agreement; and
 - .2 the Contractor shall:
 - (1) comply with the requirements in GC 13.5.7 in respect of Confidential Information;
 - (2) stop, and cause all Subcontractors, Suppliers and Sub-subcontractors to stop, all Work in progress and refrain from undertaking any further commitments;
 - (3) except for subcontracts to be assigned to the Owner pursuant to GC 3.8.2.3(4), terminate any subcontracts related to the Work;
 - (4) minimize all costs resulting from the termination of the Agreement; and
 - (5) at the Owner's option, deliver, or cause to be delivered, to the Owner all Work-in-process obtained or performed by the Contractor and the Subcontractors, Suppliers and Sub-subcontractors up to the effective date of termination (including all Work-in-process situate at locations other than the Site and Contractor Prepared Documents).

11. DISPUTE RESOLUTION

11.1 DISPUTE RESOLUTION

- 11.1.1 Unless the Agreement has been terminated or completed, the Contractor shall in every case, notwithstanding any Claim Notice or the occurrence of a Dispute, continue to proceed with the Work with due diligence and expedition. Such continuance shall not jeopardize the Contractor's entitlement in respect of such Claim Notice or Dispute, provided the Contractor has complied with all other requirements of the Agreement.
- 11.1.2 The parties acknowledge and agree that, for the purposes of Part II.1 of the Construction Act, there shall be no dispute with respect to an Adjudicable Matter that is also the subject matter of a Claim Notice, unless and until a Claim Notice in accordance with GC 7.7 – CLAIMS PROCEDURE has been received by the Owner and the Contract Administrator, and the Owner or the Contract Administrator, as the case may be, has issued a determination to the Contractor regarding the validity of the Claim Notice pursuant to GC 7.7.6.

Construction Agreement

Schedule D – General Conditions

11.1.3 The parties acknowledge that no arbitration, action, suit or other proceeding shall be brought, nor any mediation undertaken, with respect to the subject matter of a Claim Notice unless and until a Claim Notice in accordance with GC 7.7 has been received by the Owner and the Contract Administrator, and the Owner or the Contract Administrator, as the case may be, has issued a determination to the Contractor regarding the validity of the Claim Notice pursuant to GC 7.7.6.

11.2 ADJUDICATION

11.2.1 The parties acknowledge and agree that, for the purposes of paragraph 7 of s. 13.5(1) of the Construction Act:

- .1 neither the Agreement nor any Schedule sets out “any other matter” that the parties agree may be referred to an Adjudication; and
- .2 the parties may agree after the commencement of the Agreement to “any other matter” that may be referred to an Adjudication provided such agreement is in writing and explicitly identifies and refers to the other matter to refer to an Adjudication.

11.2.2 All Adjudications shall proceed in accordance with the provisions of the Construction Act and the additional procedures set out in this 12.2 - ADJUDICATION, subject to the exercise of the powers provided to the Adjudicator under section 13.12 of the Construction Act.

11.2.3 Subject to GC 7.7 – CLAIMS PROCEDURE and GC 12.1.2, at any time prior to the completion of the Agreement, either party may refer an Adjudicable Dispute to Adjudication, by giving a Notice of Adjudication to the other party.

11.2.4 If the party issuing the Notice of Adjudication is the:

- .1 Contractor, the Notice of Adjudication shall be given to:

City of Toronto
Adjudication Unit
C/O City Solicitor's Office
Metro Hall, 26th Floor
55 John Street
Toronto, Ontario M5V 3C6

- .2 Owner, the Notice of Adjudication shall be given to the person at the address set out in row A.3 of the Information Sheet.

The Notice of Adjudication shall be given to the other party by registered mail, courier or hand delivery.

11.2.5 Delivery of the Notice of Adjudication by registered mail is deemed given on the fifth day after the Notice of Adjudication is mailed.

Construction Agreement

Schedule D – General Conditions

- 11.2.6 Delivery of the Notice of Adjudication by courier is deemed given on the second day following the day the courier was given the document, unless the second day is a holiday, in which case the Notice of Adjudication is deemed given on the next day that is not a holiday.
- 11.2.7 The seat of the Adjudication shall be in Toronto, Ontario.
- 11.2.8 In addition to the requirements of section 13.8 of the Construction Act, if an Adjudication between the Owner and the Contractor is with respect to an Adjudicable Matter that is the same or includes the subject matter of disputes that can be referred to adjudication between:
- .1 the Contractor and Subcontractors and/or Suppliers that are to be adjudicated in separate Adjudications, if a Subcontractor and/or Supplier does not agree to a consolidated Adjudication, the Owner shall be entitled, in its sole and absolute discretion, to direct the Contractor to, and the Contractor shall, require the consolidation of the Adjudication through the exercise of the Contractor's right pursuant to section 13.8(2) of the Construction Act; or
 - .2 the Owner and other contractors engaged by the Owner to perform work on the improvement that are to be adjudicated in separate Adjudications, the Contractor hereby acknowledges and agrees to the consolidation of the separate Adjudications if the Owner requires the consolidation of the separate Adjudications and such other contractors have also agreed to the consolidation of the separate Adjudications.
- 11.2.9 The Adjudicator nominated by the party issuing the Notice of Adjudication shall:
- .1 have relevant qualifications and experience with respect to the Project or projects of a similar nature and magnitude, to the Project;
 - .2 be independent of and at arm's length to Contractor, Owner and any other person having an interest in the Project or any of the documents comprising the Agreement; and
 - .3 have no conflict of interest relating to the parties or the Dispute.
- 11.2.10 In addition to the requirements of section 13.11 of the Construction Act, the copy of the contract and any other documents delivered to the party that received the Notice of Adjudication pursuant to section 13.11 of the Construction Act shall:
- .1 be delivered to such party by the other party in the manner as required by the Adjudicator;
 - .2 if the contract and such documents have an aggregate file size in excess of twenty (20) MB, be delivered to such party by the other party on a USB flash drive or using a secure electronic document exchange service in a searchable format; and

Construction Agreement

Schedule D – General Conditions

- .3 include an index of documents with identifying information (for example, date, document description, author/recipient).

11.2.11 The Contractor and Owner hereby acknowledge and agree that:

- .1 they shall, immediately after the appointment of the Adjudicator, either through the agreement of the parties or by the Authorized Nominating Authority ("**ANA**"), deliver a written agreement requesting that the Adjudicator provide the party that received the Notice of Adjudication no less than fourteen (14) Calendar Days from the date of receipt of the documents pursuant to section 13.11 of the Construction Act to respond;
- .2 if the documents delivered pursuant to section 13.11 of the Construction Act:
 - (1) exceed 100 documents or 1000 pages in the aggregate, excluding the Agreement and all Schedules; or
 - (2) seek monetary relief in excess of one million dollars (\$1,000,000) exclusive of Value Added Taxes,

they shall, immediately after the receipt of such documents, deliver to the Adjudicator a written agreement requesting that the Adjudicator provide the party that received the Notice of Adjudication no less than sixty (60) Calendar Days from the date of receipt of such documents to respond and extend the deadline for the Adjudicator to make its determination to no less than thirty (30) Calendar Days after the deadline for the delivery of the response by such party; and

- .3 if the documents delivered pursuant to section 13.11 of the Construction Act are delivered at any time between the Friday prior to December 25th in a given year and the first Monday of January of the following year, they shall, immediately after the receipt of such documents, deliver to the Adjudicator a written agreement requesting that the Adjudicator exclude the period between the date of delivery of such documents and that first Monday of January from the counting of Calendar Days for the purposes of the Adjudication and, as necessary to give effect to such exclusion, extend the deadline for the party that received the Notice of Adjudication to respond and the deadline for the Adjudicator to make its determination.

11.2.12 The Adjudicator shall be entitled to grant any remedy or relief which is consistent with the intentions of the parties expressed under the Agreement but shall not be entitled to exercise the power of prerogative writs.

11.2.13 In addition to the requirements of section 13.19(1) of the Construction Act, a requirement to pay an amount in accordance with section 13.19 of the Construction Act is subject to GC 13.2.1.2.

11.2.14 Other than in accordance with the Construction Act, any determination and reasons of an Adjudicator on the Project shall not be relied upon by either party on any other projects. The determination and reasons of any adjudicators on any other projects shall not be relied upon by the parties in any Adjudication on the Project.

Construction Agreement

Schedule D – General Conditions

11.2.15 If an Adjudicable Dispute is referred to Adjudication and such Adjudicable Dispute is already the subject of a mediation pursuant to GC 12.4 - MEDIATION, an arbitration pursuant to GC 12.5 - ARBITRATION or a court proceeding, which has not been finally determined, the party responding to the Notice of Adjudication shall be entitled, in its sole and absolute discretion, to choose to:

- .1 terminate, suspend or proceed with such mediation or arbitration, as applicable, and if the responding party elects to terminate such mediation or arbitration, as applicable, the party referring the Adjudicable Dispute to Adjudication shall be responsible for all costs of the mediator or arbitrator, as applicable, up to the date of receipt of the Notice of Adjudication; or
- .2 stay or proceed with such court proceeding, and if the responding party elects to stay such court proceeding, the party referring the Adjudicable Dispute to Adjudication shall execute all further documents and do all other lawful things necessary to give full effect to such stay, and after the Adjudicator makes its determination, either party may move to lift such stay, which the other party shall consent to.

11.2.16 The Contractor shall, in respect of any dispute between:

- .1 the Contractor and a Subcontractor or Supplier;
- .2 a Sub-subcontractor and a Subcontractor or Supplier; or
- .3 a Sub-subcontractor and another Sub-subcontractor,

no later than two (2) Working Days after the receipt by the Adjudicator of the documents under section 13.11 of the Construction Act in respect of such dispute, deliver a Notice in Writing to the Contract Administrator and Owner setting out the date which such Adjudicator received such documents.

11.3 NEGOTIATIONS

11.3.1 Either party may initiate negotiations of any Dispute by giving written notice to the other party (“**Notice of Negotiations**”) with reasonable particulars of the Dispute. After the receipt of a Notice of Negotiations the parties shall make all reasonable efforts to resolve the Dispute by amicable negotiations and the parties agree to provide, without prejudice, open and timely disclosure of relevant facts, information, and documents to facilitate such negotiations.

11.3.2 Any applicable negotiations shall be completed as soon as possible and shall be limited to a period of no more than ninety (90) Calendar Days following the delivery of a Notice of Negotiations, or such other period of time as the Parties agree in writing.

11.4 MEDIATION

11.4.1 Subject to GC 12.1.3, the parties, by mutual written agreement, may submit any Dispute to mediation. Such mediation shall proceed in accordance with this 12.4 – Mediation and such other terms and conditions agreed to by the parties.

Construction Agreement

Schedule D – General Conditions

- 11.4.2 The mediator shall be mutually agreed upon by the Owner and Contractor.
- 11.4.3 Subject to GC 12.2.15.1, each party is responsible for its own costs related to the mediation. The costs of the mediator shall be equally shared by the Owner and Contractor.

11.5 ARBITRATION

- 11.5.1 Subject to GC 12.1.3, the parties, by mutual written agreement, may submit any Dispute to be finally determined by arbitration before a sole arbitrator, who shall also be agreed to as a part of such mutual agreement. The provisions of the *Arbitration Act, 1991* (ON) shall apply to such arbitration, including the provisions for appeal therein except as otherwise provided in this 12.5 - ARBITRATION and such arbitration shall be subject to such other terms and conditions agreed to by the parties.
- 11.5.2 If the parties agree to arbitration to resolve a Dispute, the Owner shall notify the Contract Administrator in writing within fifteen (15) Calendar Days of the written agreement to arbitrate.
- 11.5.3 Subject to GC 12.2.15.1, unless otherwise agreed to in the written agreement to arbitrate, each party is responsible for its own costs related to the arbitration and the arbitrator shall not have the discretion to award costs related to the arbitration. The costs of the arbitrator and any other Persons appointed to assist the arbitrator (including independent experts) shall be equally shared by the Owner and Contractor.
- 11.5.4 The arbitrator's reasoned decision shall be made in writing within ninety (90) Calendar Days of the conclusion of the hearing. An extension of time to make a decision may be granted with consent of both parties.
- 11.5.5 The resolution of Disputes pursuant to this 12.5 - ARBITRATION shall be final and binding upon the parties, and there shall be no appeal therefrom, including any appeal to a court of law on a question of law, a question of fact, or a question of mixed fact and law.

11.6 RIGHTS OF BOTH PARTIES

- 11.6.1 Unless the parties agree otherwise, no action taken under GC 12.1 to GC 12.5 by either party shall be construed as a renunciation or waiver of any of the rights or recourse available to the parties.

12. OTHER PROVISIONS

12.1 OWNERSHIP OF EXISTING MATERIALS AND EQUIPMENT

- 12.1.1 Unless otherwise specified, all materials, equipment and other property existing at the Site at the time of execution of the Agreement shall remain the property of the Owner or any other Person identified by the Owner.

12.2 CONSTRUCTION LIENS

- 12.2.1 Upon the receipt of a written notice of lien, claim for lien or a certificate of action under the Construction Act, arising from the performance of the Work by any Subcontractor, Supplier or Sub-subcontractor:
- .1 the Contractor at its sole cost, shall take whatever steps are necessary to discharge, release or vacate such claim for lien or certificate of action, or withdraw the written notice of a lien within ten (10) Calendar Days of it coming to the notice of the Contractor. If the claim for lien or certificate of action is merely vacated, the Contractor shall, if requested, undertake the Owner's defence of any subsequent lawsuit commenced in respect of the claim for lien or certificate of action at the Contractor's sole cost; and
 - .2 the Owner may retain an amount sufficient to satisfy such claim for lien, certificate of action or written notice of a lien, including an amount sufficient to cover potential costs, in accordance with GC 5.10 – OWNER'S SET-OFF.
- 12.2.2 If the Contractor fails or refuses to vacate or discharge the claim for lien or certificate of action, or cause the withdrawal of the written notice of a lien, within the time period required by 13.2.1, the Owner shall at its option, be entitled (but not obliged) to take whatever steps are necessary to vacate and/or discharge the claim for lien or certificate of action, or cause the withdrawal of the written notice of a lien and all Losses incurred by the Owner in so doing (including all legal fees and disbursements) may be set-off by the Owner in accordance with 5.10 – OWNER'S SET-OFF.
- 12.2.3 After the Contractor or the Owner, as the case may be, has vacated and/or discharged the claim for lien or certificate of action, or caused the withdrawal of the written notice of a lien, then any amount retained by the Owner pursuant to GC 13.2.1.2 in respect of such claim for lien, certificate of action or written notice of lien shall be eligible to be included in the next Proper Invoice submitted by the Contractor.
- 12.2.4 The Contractor acknowledges that all claims for lien shall be given to the Clerk of the City of Toronto through its web portal at www.toronto.ca/liens.
- 12.2.5 This 13.2 – CONSTRUCTION LIENS does not apply to any claim for lien or certificate of action to the extent arising from a payment default of the Owner under the Agreement.

12.3 OWNERSHIP OF CONTRACTOR DOCUMENTS

- 12.3.1 Subject to GC, 1.1.11, all correspondence, data, plans, drawings, specifications, reports, estimates, summaries, photographs, models, mockups, Contractor Records and all other information and documentation in any form (an whether in draft or final format) prepared by or for the Contractor in connection with, or arising out of the Work or the Agreement (collectively, the "**Contractor Prepared Documents**") shall be the exclusive property of the Owner, provided the Contractor shall retain the copyright in the Contractor Prepared Documents prepared by the Contractor. The Contractor grants the Owner an irrevocable, perpetual, royalty free and cost free license to use, amend and copy the Contractor Prepared Documents in any manner it chooses

Construction Agreement

Schedule D – General Conditions

including the construction, design, testing, refurbishment, use, modification, expansion, occupancy, operation, maintenance, renovation, management, sale, extension, alteration and repair of the Work, the Site, the Project or any part thereof or any other project or any work including providing the Contractor Prepared Documents to consultants, design-builders, construction managers, contractors, suppliers and others for such purposes. Such license shall survive the termination of the Agreement.

- 12.3.2 In the event of any termination of the Agreement or as requested by the Owner, from time to time, the Contractor agrees to promptly, and in no event later than within ten (10) Working Days after such termination, deliver the Contractor Prepared Documents to the Owner.

12.4 OWNER SUPPLIED MATERIAL

- 12.4.1 The Contractor shall, in advance of receipt of shipments of Owner Supplied Material, provide adequate and proper storage facilities acceptable to the Contract Administrator and on the receipt of the Owner Supplied Material shall immediately place it in storage except where it is to be incorporated forthwith into the Work.
- 12.4.2 The Contractor shall be responsible for acceptance of Owner Supplied Material, at the specified delivery point. All Owner Supplied Material in each shipment shall be accounted for by the Contractor. Immediately upon receipt of each shipment, the Contractor shall provide the Contract Administrator with copies of bills of lading, or such other documentation the Contract Administrator may require to substantiate and reconcile the quantities of Owner Supplied Material received. Where Owner Supplied Material arrives at the delivery point in a damaged condition or where there are discrepancies between the quantities received and the quantities shown on the bills of lading, the Contractor shall immediately report such damage or discrepancies to the Contract Administrator who shall arrange for an immediate inspection of the shipment. Where damage or deficiencies are not so reported, it shall be assumed that the shipment arrived in good condition and order, and any damage or deficiencies reported thereafter shall be made good by the Contractor at no extra cost to the Owner and without any extension of the Contract Time.
- 12.4.3 Once accepted by the Contractor, notwithstanding that title to the Owner Supplied Equipment shall be held by the Owner, the risk of Loss to the Owner Supplied Material shall be borne by the Contractor. If after accepting delivery, such Owner Supplied Material is damaged or lost while under the control of the Contractor, it shall be replaced or repaired by the Contractor at no cost to the Owner, and to the satisfaction of the Contract Administrator. If such Owner Supplied Material is rejected by the Contract Administrator for reasons that are not the fault of the Contractor, it shall remain in the care and at the risk of the Contractor until its disposition has been determined by the Contract Administrator.
- 12.4.4 Owner Supplied Material shall not, except with the written permission of the Contract Administrator, be used by the Contractor for purposes other than the performance of the Work under the Agreement. Contractor shall store, operate, maintain, repair and otherwise deal with the Owner Supplied Material in the same manner as would a prudent owner of such material and equipment, and in accordance with the

Construction Agreement
Schedule D – General Conditions

Agreement and the applicable operating and maintenance manuals, and using suitably qualified and experienced Personnel, until returned to the Owner.

- 12.4.5 Empty reels, crates, containers and other types of packaging from Owner Supplied Material shall become the property of the Contractor when they are no longer required for their original purpose and shall be disposed of by the Contractor at the Contractor's cost unless otherwise specified in the Agreement or directed by the Owner.
- 12.4.6 Where Owner Supplied Material supplied by the Owner is ordered and stockpiled prior to the award of the Agreement, the Contractor shall, at no extra cost to the Owner, immediately upon commencement of operations, check the Owner Supplied Material, report any damage or deficiencies to the Contract Administrator and take charge of the Owner Supplied Material at the stockpile site. Where damage or deficiencies are not so recorded by the Contractor, it shall be assumed that the stockpile was in good condition and order when the Contractor took charge of it, and any damage or deficiencies reported thereafter shall be made good by the Contractor at no extra cost to the Owner and without any extension of the Contract Time.

12.5 CONFIDENTIAL INFORMATION AND PERSONAL INFORMATION

- 12.5.1 The parties acknowledge and agree that MFIPPA applies to the Owner and the Owner Documents and that the Owner is required to fully comply with MFIPPA. The Contractor shall retain and preserve Owner Documents in a secure and accessible manner to enable the Owner to fulfill its obligations under MFIPPA and the Owner's Policies, Procedures and By-laws.
- 12.5.2 Notwithstanding anything else in the Agreement to the contrary, the Contractor acknowledges and agrees that the Owner has a right to disclose or publish the Agreement (including any or all terms hereof), any or all Owner Documents and any information derived from the Owner Documents as the Owner, in its sole discretion, may consider appropriate.
- 12.5.3 Each party acknowledges the importance of maintaining the confidentiality and privacy of Confidential Information. Except as authorized hereunder, each receiving party shall, with respect to Confidential Information it receives from or on behalf of any disclosing party at all times:
- .1 hold such Confidential Information in strict confidence, under and in accordance with all applicable requirements of the Agreement including the Specifications, if any;
 - .2 implement and use, appropriate technical, organizational and physical security measures to protect and secure such Confidential Information, whether in storage or in use, with no less than the same degree of care as the receiving party uses to protect its own Confidential Information against loss, theft and unauthorized access, use, copying, modification, disclosure, publication or dissemination or disposal, but in no case with less than a reasonable degree of care. Further, the Contractor shall comply, if requested by the Owner, with a document control and security protocol approved by the Owner, which protocol

Construction Agreement
Schedule D – General Conditions

shall prescribe limitations on the use, disclosure and storage of such Confidential Information;

- .3 comply with all applicable requirements of Laws, including MFIPPA, the *Personal Information Protection and Electronic Documents Act (Canada)*, and any other Laws now in force or that may in the future come into force governing the collection, use, disclosure and protection of Personal Information applicable to the Contractor;
- .4 not disclose to a third party and not permit any third party any manner of access to, whether directly or indirectly, such Confidential Information without the prior written approval of the disclosing party in each instance, except as provided for in this 13.5 – CONFIDENTIAL INFORMATION AND PERSONAL INFORMATION; and
- .5 not to use such Confidential Information for any purpose whatsoever other than in connection with the rights conferred under the Agreement as permitted by the Agreement.

12.5.4 The parties agree that:

- .1 the receiving party may disclose Confidential Information of the disclosing party received by it pursuant to the Agreement:
 - (1) to its Personnel if and when such Personnel have a need to know such Confidential Information so that such receiving party may exercise its rights and/or meet its obligations under the Agreement or comply with Laws, provided that such Personnel are advised of the confidential nature of the Confidential Information and, by virtue of the terms of their employment, engagement or retainer or as a result of an agreement in writing, are bound by confidentiality obligations substantially no less restrictive than those imposed on the receiving party pursuant to the Agreement;
 - (2) to the extent such disclosure is required pursuant to Laws or any Governmental Authority, provided that, where circumstances permit, prior to such disclosure the receiving party shall to the extent it is legally permitted to do so give the disclosing party a notice of the potential disclosure and allow the disclosing party the opportunity to contest the requirement for disclosure or seek a protective order or ruling in connection with such potential disclosure;
 - (3) as necessary in connection with any dispute resolution commenced pursuant to the Agreement; and
 - (4) as may be permitted or required under the *City of Toronto Act, 2006*;
- .2 the Contractor may disclose Confidential Information of the Owner to its professional advisors, Subcontractors, Suppliers or Sub-subcontractors, to the extent necessary, to enable that party to perform, to cause to be performed the Work, or to enforce, its rights or obligations under the Agreement, provided that

Construction Agreement

Schedule D – General Conditions

such parties are advised of the confidential nature of the Confidential Information and bound in writing to confidentiality obligations in favour of both the Owner and Contractor substantially no less restrictive than those imposed on Contractor by the Agreement;

- .3 the Owner may disclose Confidential Information of the Contractor to its professional advisors, consultants, other contractors, Personnel and any other party providing or potentially providing services to the Owner to enable the Owner to perform any of its obligations or exercise any of its rights under the Agreement, provided that such parties are advised of the confidential nature of the Confidential Information and bound in writing to confidentiality obligations substantially no less restrictive than those imposed on the Owner by the Agreement; and
 - .4 any disclosure of Confidential Information allowed pursuant to this 13.5 - CONFIDENTIAL INFORMATION AND PERSONAL INFORMATION shall be limited to that which is necessary to satisfy the need for such disclosure.
- 12.5.5 The Contractor acknowledges that the Owner may use the Confidential Information of Contractor for purposes not specific to the Project, but for other general governmental purposes.
- 12.5.6 Each receiving party shall immediately provide Notice in Writing to a disclosing party in the event that it becomes aware of any actual or suspected loss, theft or accidental or unauthorized access, disclosure, copying, use, modification or destruction of Confidential Information by a receiving party or any party to which a receiving party has disclosed any Confidential Information.
- 12.5.7 The Contractor shall allow the Owner on reasonable Notice in Writing to inspect any Confidential Information in the custody or possession of a Contractor Party and to audit compliance with this GC including the measures used to protect Confidential Information, and otherwise properly respond to all reasonable inquiries of the Owner with respect to handling of Confidential Information within five (5) Working Days.
- 12.5.8 The Contractor shall provide, and shall cause each of its professional advisors, Subcontractors, Suppliers or Sub-subcontractors to provide, in a timely manner, all necessary and reasonable information and co-operation to the Owner and to any Governmental Authorities with jurisdiction or oversight over Laws governing the collection, use, disclosure and protection of Personal Information in connection with any investigations, audits or inquiries made by any such bodies or authorities under such legislation.
- 12.5.9 Subject to any applicable requirement of Laws, the Contractor shall on the earliest of the date of Total Performance of the Work, termination or expiry of the Agreement or upon the written request of the Owner, immediately cease all use of and return to the Owner or, at the direction of the Owner, dispose of, destroy, or render permanently anonymous, all Confidential Information, in each case using appropriate technical, organizational and physical security measures to protect Confidential Information against loss, theft and unauthorized access, disclosure, copying, use or modification.

Construction Agreement
Schedule D – General Conditions

- 12.5.10 This 13.5 – CONFIDENTIAL INFORMATION AND PERSONAL INFORMATION shall not apply in respect of information (except for Personal Information), if such information:
- .1 was lawfully acquired by the receiving party prior to the Effective Date without any restrictions as to use or disclosure or any obligation of confidentiality;
 - .2 is lawfully, and without any restrictions as to use or disclosure or any obligation of confidentiality, provided to a receiving party by a third party, except where the third party is known or should reasonably have been suspected of being subject to an obligation to the disclosing party to maintain such information in confidence;
 - .3 is independently created, developed or acquired by or for the receiving party without reference to the Confidential Information provided by the disclosing party or through third parties to whom the Confidential Information had not been disclosed; or
 - .4 is released from the confidentiality provisions of the Agreement by the written authorization of the disclosing party.
- 12.5.11 The obligations in this 13.5 – CONFIDENTIAL INFORMATION AND PERSONAL INFORMATION shall survive the termination of the Agreement. To the extent of any conflict or inconsistency between this GC and any other provision of the Agreement, this GC shall prevail.

SCHEDULE E

VALUING CHANGES IN THE WORK

1. CHANGES IN THE WORK BASED ON UNIT PRICES SET OUT IN THE AGREEMENT

- 1.1** Notwithstanding that the number of units of an item of Unit Price Work to be performed shall exceed or be less than the Estimate of Units for Completion, subject to section 1.2 of this Schedule E, the Contractor shall proceed to perform the applicable Unit Price Work and payment shall be made for the final quantities of total units for such item in accordance with GC 5.3.5.2.
- 1.2** When the number of units of a Major Item of Unit Price Work exceeds the Estimate of Units for Completion for such item by more than 30%, the Contractor shall not proceed with the portion of such Major Item of Unit Price Work in excess of 130%, but the Owner shall have the right, in its sole discretion, to require that the portion of the applicable Unit Price Work for such Major Item which exceeds 130% of the Estimate of Units be performed and paid for as a T&M Change in the Work, in accordance with Section 3 of this Schedule E and if the Owner so elects, the Contract Administrator shall issue a Change Directive pursuant to GC 7.3 – CHANGE DIRECTIVE, or the parties shall sign a Change Order pursuant to GC 7.2 – CHANGE ORDER, reflecting the change for this portion of the Unit Price Work. For clarity:
- 1.2.1 where the number of units of a Major Item exceeds 100% of the applicable Estimate of Units for Completion for such Major Item, the units of such Major Item which are less than 130% of the Estimate of Units for Completion of such Major Item shall be paid for at the Unit Prices in accordance with GC 5.3.5.2;
- 1.2.2 where the number of units of an item of Unit Price Work (other than Major Items) exceeds 100% of the Estimate of Units for Completion for such item, all units of such item (including any units in excess of 130% of the applicable Estimate of Units for Completion) shall be paid for at the Unit Prices in accordance with GC 5.3.5.2; and
- 1.2.3 the Unit Prices under "Schedule A Schedule of Prices for Changes in the Work", if attached to Schedule B - Pricing Form, shall apply to an item of Unit Price Work if there is no corresponding Unit Price set out elsewhere in Schedule B – Pricing Form for such item.

2. CHANGES IN THE WORK ON A NEGOTIATED FIXED PRICE OR NEGOTIATED UNIT PRICE BASIS

- 2.1** The negotiated fixed price for a change in the Work or negotiated unit price(s) for the components of a change in the Work, as the case may be, whether performed by the Contractor or a Subcontractor, Supplier or Sub-subcontractor, shall be inclusive of all costs, charges, expenses, fees and taxes whatsoever required or related to the performance of such change in the Work and markup as provided for in section 2.2.3 of this Schedule E, with the exception of Value Added Taxes.

Construction Agreement

Schedule E – Valuing Changes in the Work

- 2.2** The negotiated fixed price for a change in the Work or negotiated unit price(s) for the components of a change in the Work, as the case may be, shall be the sum of the following:
- 2.2.1 the negotiated fixed price or negotiated unit price(s), as applicable, for the portions of the change in the Work to be carried out by the Contractor's Personnel, without markup by the Contractor;
 - 2.2.2 the negotiated fixed price or negotiated unit price(s), as applicable for the portions of the change in the Work to be carried out by the Subcontractors, Suppliers or Sub-subcontractors, without markup by the Contractor, Subcontractor, Supplier or Sub-subcontractor; and
 - 2.2.3 markup calculated as follows:
 - .1 multiplying the negotiated amount set out in section 2.2.1 of this Schedule E by the percentage amount described in row B.1 of the Information Sheet; and
 - .2 multiplying the negotiated amount set out in section 2.2.2 of this Schedule E by the percentage amount described in row B.2 of the Information Sheet.
- Such markup percentages shall not be adjusted during the term of the Agreement. Notwithstanding any other provision in the Agreement, the cumulative total percentage markup charged by the Contractor, Subcontractors, Suppliers and Sub-subcontractors pursuant to section 2.2.3.2 of this Schedule E shall not exceed the percentage amount set out in row B.2 of the Information Sheet, regardless of the extent to which the change in the Work is performed by a Subcontractor, Supplier or Sub-subcontractor. For greater certainty, such markup percentage shall not apply to Value Added Taxes. Any change in Work performed by a Subcontractor, Supplier and Sub-subcontractor that is an "associate" (as defined by the Securities Act) of the Contractor shall be treated as if such change in the Work was performed by the Contractor for the purposes of calculating the markup and, in such an instance, the markup in section 2.2.3.1 of this Schedule E is applicable, not the markup in section 2.2.3.2 of this Schedule E.
- 2.3** The Contractor shall provide written quotes identifying each amount to be charged by the Contractor and each Subcontractor, Supplier and Sub-subcontractor, including for each of the foregoing, a detailed breakdown of amounts for transportation, labour, Product, Construction Equipment, services. The Value Added Taxes, as applicable, shall be identified separately in a manner satisfactory to the Owner. The Contractor shall also provide any other detail reasonably required by the Owner to evaluate the proposed fixed price of the change in the Work.
- 2.4** Where such change in the Work requires the rental of Construction Equipment, any rental charges for the actual operation time required for the performance of the change in the Work must be agreed upon by the parties before the Contractor commences the change in the Work.

Construction Agreement

Schedule E – Valuing Changes in the Work

- 2.5** The markups provided for in section 2.2.3 of this Schedule E shall constitute the only compensation the Contractor shall be entitled to for any and all overhead, profit, incidental and administrative costs whatsoever related to the change, including, costs relating to superintendence and supervision, shop drawing production, estimating, site office and home office expenses, tools of Personnel, temporary facilities and controls, and coordination of any and all Work-related activities.
- 2.6** If such change in the Work results in a net decrease in the Fixed Price, the Fixed Price shall be decreased by an amount proportionate to the reduction in the Fixed Price Work, provided that such reduction shall not include any amounts for portions of the Fixed Price relating to the fixed overhead costs incurred by the Contractor as reasonably substantiated by the Contractor.
- 3. CHANGES IN THE WORK ON A TIME AND MATERIAL BASIS – VERTICAL APPROACH**
- 3.1** For the purposes of this Section 3 of this Schedule E, the following definitions apply:
- 3.1.1 **“T&M Costs”** has the meaning set out in section 3.2.1 of this Schedule E;
- 3.1.2 **“T&M Markup”** has the meaning set out in section 3.4.2 of this Schedule E;
- 3.1.3 **“T&M Percentage Markup”** has the meaning set out in section 3.2.2 of this Schedule E;
- 3.1.4 **“T&M Price”** means, in respect of a T&M Change in the Work, the total T&M Costs plus the T&M Markup.
- 3.2** For T&M Changes in the Work, the following shall apply:
- 3.2.1 the cost of performing the T&M Change in the Work shall be calculated using the provisions of section 3.5 of this Schedule E, subject to all applicable credits being deducted and section 3.11 of this Schedule E (**“T&M Costs”**); and
- 3.2.2 the percentage markup shall be determined in accordance with section 3.3 of this Schedule E (**“T&M Percentage Markup”**).
- 3.3** The T&M Percentage Markup applicable to T&M Change in the Work shall be determined as follows:
- 3.3.1 on T&M Changes in the Work performed by Contractor: the percentage amount set out in row B.3 of the Information Sheet; and
- 3.3.2 on T&M Changes in the Work performed by the Subcontractor or Supplier or Sub-subcontractors: the percentage amount set out in row B.4 of the Information Sheet.

The T&M Percentage Markup shall not be adjusted during the term of the Agreement. Notwithstanding any other provision in the Agreement, the cumulative total percentage markup charged by the Contractor, Subcontractors, Suppliers and all Sub-

Construction Agreement

Schedule E – Valuing Changes in the Work

subcontractors pursuant to section 3.3.2 of this Schedule E shall not exceed the amount set out in row B.4 of the Information Sheet, regardless of the extent to which the change in the Work is performed by a Subcontractor, Supplier or Sub-subcontractor. For greater certainty, the percentage markup shall not apply to Value Added Taxes. Any change in Work performed by a Subcontractor, Supplier and Sub-subcontractor that is an “associate” (as defined by the Securities Act) of the Contractor shall be treated as if such change in the Work was performed by the Contractor for the purposes of calculating the T&M Percentage Markup and, in such an instance, the T&M Percentage Markup in section 3.3.1 of this Schedule E is applicable, not the markup in section 3.3.2 of this Schedule E.

3.4 If the T&M Change in the Work results in a net increase in the Contractor’s cost, the Contract Price shall be increased by:

3.4.1 the T&M Costs; plus

3.4.2 the T&M Percentage Markup multiplied by the T&M Costs (“**T&M Markup**”),

3.5 The T&M Costs shall be the actual reasonable costs to the extent directly paid by the Contractor in performing such T&M Change in the Work in accordance with the Agreement (without any markup) and, subject to section 3.11 of this Schedule E, is limited to the actual reasonable costs of the following:

3.5.1 salaries, wages and benefits paid to Personnel in the direct employ of the Contractor applying the labour rates as agreed in writing between the Owner and Contractor for Personnel:

- .1 carrying out the T&M Change in the Work, including, to the extent the T&M Change in the Work results in an extension of the Contract Time, project managers, superintendents, assistants, watch persons and administrative Personnel;
- .2 engaged in expediting the production or transportation of material or equipment, at shops or on the road; or
- .3 engaged in the preparation of Shop Drawings, fabrication drawings, coordination drawings and As-Built Drawings.

The Contractor acknowledges that the agreed upon labour rates (including the underlying salaries, wages and benefits on which the labour rates were calculated) shall be subject to audit and verification by the Owner in accordance with GC 2.6 and adjustment as appropriate.

3.5.2 contributions, assessments or taxes incurred for such items as employment insurance, provincial or territorial health insurance, workers’ compensation, and Canada or Quebec Pension Plan, insofar as such cost is based on wages, salaries or other remuneration paid to Personnel of the Contractor and included in the cost of the Work as provided in section 3.5.1 of this Schedule E;

3.5.3 all Products including cost of transportation thereof;

Construction Agreement

Schedule E – Valuing Changes in the Work

- 3.5.4 materials and supplies, including transportation and maintenance thereof, which are consumed in the performance of the Work; and cost less salvage value on such materials and supplies used but not consumed, which remain the property of the Contractor;
- 3.5.5 all Construction Equipment, exclusive of hand tools, and Temporary Work, used in the performance of the Work, whether rented from or provided by the Contractor or others, including installation, minor repairs and replacements, dismantling, removal, transportation, and delivery cost thereof, which for clarity, excludes the labour costs for directly operating such items included in section 3.5.1 of this Schedule E;
- 3.5.6 all equipment and services required for the Contractor's field office;
- 3.5.7 deposits lost provided that they were not lost by acts or omissions of the Contractor's Personnel;
- 3.5.8 subject to the Owner's prior written approval for amounts in excess of \$10,000, the value of subcontracts with Subcontractors and Suppliers, provided however that any time and material costs included in such amounts shall be limited to the actual costs of the items described in this section 3.5 of this Schedule E changing "Contractor" to "Subcontractor" or "Supplier" as necessary";
- 3.5.9 quality assurance required by the Agreement such as inspection and testing services, charges levied by authorities, provided such costs are pre-approved in writing by the Owner;
- 3.5.10 legal costs, incurred by the Contractor, in relation to the performance of the T&M Change in the Work provided that they are not related to or arising from a dispute between the Owner and the Contractor unless such costs are part of a settlement or awarded by adjudication, arbitration or court;
- 3.5.11 charges levied by authorities having jurisdiction at the Site;
- 3.5.12 royalties, patent licence fees and Losses for infringement of patents and cost of defending suits therefor subject always to the Contractor's obligations to indemnify the Owner as provided in GC 9.1.2.2;
- 3.5.13 any adjustment, attributable to the T&M Change in the Work, in premiums for all bonds and insurance which the Contractor is required, by the Agreement, to purchase and maintain;
- 3.5.14 any adjustment in taxes, other than Value Added Taxes and those relating to the Contractor's income or real or personal property;
- 3.5.15 duties for which the Contractor is liable;
- 3.5.16 charges for long distance telephone and facsimile communications, courier services, expressage, and petty cash items incurred in relation to the performance of the Work;

Construction Agreement

Schedule E – Valuing Changes in the Work

3.5.17 removal and disposal of waste products and debris; and

3.5.18 safety measures and requirements.

All other costs attributable to the T&M Change in the Work are included in the percentage markup calculated in accordance with the provisions of section 3.3 of this Schedule E.

- 3.6** Notwithstanding any other provisions contained in the Agreement (other than section 3.11 of this Schedule E), it is the intention of the parties that the cost of any item under any cost element referred to in section 3.5 of this Schedule E shall cover and include any and all costs or liabilities attributable to the T&M Change in the Work other than those which are the result of or occasioned by any failure on the part of the Contractor to perform the change in the Work in accordance with the Standard of Care. Any cost due to failure on the part of the Contractor to perform the change in the Work in accordance with the Standard of Care shall be borne by the Contractor.
- 3.7** The Contractor shall prepare and maintain complete and accurate Daily Contractor Work Records for T&M Changes in the Work.
- 3.8** All trade, quantity and cash discounts and rebates and refunds accrue to the Owner, including all returns from sale of surplus materials and equipment applicable to the T&M Change in the Work, and the Contractor shall make provisions for them to be secured without delay.
- 3.9** Pending determination of the final amount of a T&M Change in the Work, the undisputed value of the T&M Change in the Work performed:
- 3.9.1 as the result of a Change Order, is eligible to be included in Proper Invoices; and
 - 3.9.2 as the result of a Change Directive, is not eligible to be included in Proper Invoices except to the extent that it is dealt with in a Change Order.
- 3.10** If the Owner and the Contractor do not agree on the proposed adjustment in the Contract Time attributable to the T&M Change in the Work, or the method of determining it, the adjustment shall be referred to the Contract Administrator for determination.
- 3.11** Notwithstanding any other provisions contained in the Agreement, the T&M Costs shall not include, and no payment shall be made by the Owner for:
- 3.11.1 head office salaries, wages and benefits and all other overhead or general expenses;
 - 3.11.2 capital expenses and interest on capital;
 - 3.11.3 general clean-up, except where the performance of the T&M Change in the Work causes specific additional clean-up requirements;
 - 3.11.4 salaries, wages and benefits paid for project managers, superintendents, assistants, watch persons and administrative Personnel except only for the

Construction Agreement
Schedule E – Valuing Changes in the Work

salaries, wages and benefits of Personnel described in section 3.5.1 of this Schedule E and the related contributions, assessments or taxes referred to in section 3.5.2 of this Schedule E;

- 3.11.5 salaries, wages, benefits, rentals, or other expenses that exceed the rates that are standard in the locality of the Site that are otherwise deemed unreasonable by the Contract Administrator;
- 3.11.6 any Losses attributable to Deficiencies, the negligent acts or omissions of the Contractor Parties or the Contractor's failure to perform any of its obligations under the Agreement;
- 3.11.7 any costs noted in the Agreement as non-reimbursable by the Owner; or
- 3.11.8 any costs noted in the Agreement as paid or incurred at the Contractor's expense.

SCHEDULE F

OWNER'S POLICIES, PROCEDURES, BY-LAWS AND OTHER REQUIREMENTS

The following Toronto Zoo Official Policy Statements and procedures are included in this RFT, are applicable for this project.

SAFE-001	Occupational Health & Safety
SAFE-002	Health & Safety Hazard Reporting
SAFE-005	Hazardous Materials
SAFE-007	Confined Space
SAFE-013	Lock Out / Tag Out Procedure
SAFE-017	Contractor Safety
SAFE-018	Vehicles on Site
SAFE-025	Hot Work
SAFE-026	Scaffold & Ladder Safety

City of Toronto Fair Wage Policy: <https://www.toronto.ca/business-economy/doing-business-with-the-city/understanding-the-procurement-process/fair-wage-office-policy/fair-wage-policy/>

Toronto Zoo's Commitment to the City of Toronto's Corporate Smog Alert Response Plan.

Toronto Zoo's Accessible Customer Service Training Requirements: Contractors, Consultants and other Service Providers

SCHEDULE G

FORMS

Schedule G is comprised of the following forms:

Form 1: Sample Proper Invoice

Form 2: Certificate of Insurance

Form 3: Tax Statutory Declaration

Form 4: Notice of Adjudication

**Construction Agreement
Schedule G – Forms**

FORM 1: SAMPLE PROPER INVOICE

Contractor Company Logo

INVOICE

BILL TO:

Owner: *City of Toronto*
 Street Address: *55 John Street, 20th Floor*
 City: *Toronto, Ontario*
 Postal Code: *M5V 3C6*
 Division: *Engineering & Construction Services*

REMIT TO:

Vendor Name: *Vendor*
 Vendor Number: *123456789*
 Street Address: *123 Toronto Street, Unit 12*
 City: *Toronto, Ontario*
 Postal Code: *XXX XXX*

Owner Representative: *John Doe*

Contractor Project Manager: *John Doe*

Tel. #: *416-39X-XXXX*
 Email: *John.Doe@toronto.ca*

Tel. #: *416-39X-XXXX*
 Email: *John.Doe@Vendor.ca*

Contract #: *Contract Number*
 Blanket Contract #: (if any) *XXXXXXXX*
 PO #/ CRO#/ DPO#: *XXXXXXXX*
 Project Description: *Project Description*
 Invoice Period: *(Start) to (End)*
 Progress Payment Certificate#: *PR-XX*

INVOICE DATE: *September 19, 2019*
INVOICE # *12548*

HST Registration No. _____
 Currency _____

Item	Contract Price	Progress To Date		Previous Billing	Current Billing
		%	\$		
A	B	C = (D / B)	D	E	F = (D - E)
Base Contract	\$0.00	0.00%	\$0.00	\$0.00	\$0.00
Allowances	\$0.00	0.00%	\$0.00	\$0.00	\$0.00
Approved Change Orders (non-Allowance)	\$0.00	0.00%	\$0.00	\$0.00	\$0.00
Gross Amount	\$0.00	0.00%	\$0.00	\$0.00	\$0.00
Less: Statutory Lien Holdback			\$(0.00)	\$(0.00)	\$(0.00)
Less: Contractual Holdbacks			\$(0.00)	\$(0.00)	\$(0.00)
Net Amount			\$0.00	\$0.00	\$0.00
HST 13%			\$0.00	\$0.00	\$0.00
Less: Other Taxes			\$(0.00)	\$(0.00)	\$(0.00)
Total Amount Due					\$0.00

Name: _____

Signature: _____

Title: _____

Date: _____

Additional information to be included/attached

FORM 2: CERTIFICATE OF INSURANCE

To be completed only by the insurer or by its representative.

Name of Insured:	City of Toronto Contact Name, Address, and Telephone Number:
Address and Telephone Number of Insured:	

Operations of Named Insured for which certificate is issued:

(NOTE: Provide specific project information including the Toronto Zoo contract number)

1. Commercial General Liability: Deductible \$ _____

Insuring Company	Policy Number	Policy Limit(s) \$ (per occurrence)	Effective Date (yyyy-mm-dd)	Expiry Date (yyyy-mm-dd)
Primary Insurer:				
Umbrella/Excess Insurer:				
<input type="checkbox"/> Applicable to Auto Coverage				
Contractor's Pollution Liability, Sudden and Accidental and Gradual, if applicable				

Commercial General Liability policy provisions:

- a) The CITY OF TORONTO, ITS BOARDS, AGENCIES, COMMISSIONS OR SUBSIDIARY OPERATIONS, AS APPLICABLE, the TORONTO AND REGION CONSERVATION AUTHORITY, and the CONSULTANT are included as Additional Insureds but only with respect to liability arising out of the operations of the Insured for which a contract or proposal is issued by the Toronto Zoo.
- b) The policy includes a Cross-Liability and Severability of Interest, Blanket Form Contractual Liability, Owner's and Contractor's Protective Liability, Broad Form Property Damage, Contingent and/or Employer's Liability, Non-Owned Automobile Liability, Products/Completed Operations and any other provision relevant to the contract work. If applicable to the insured operations, coverage for Blasting, Pile Driving and Collapse.
- c) The Commercial General Liability Policy(ies) identified above shall apply as primary insurance and not excess to any other insurance available to the City.

2. Automobile Liability, if applicable: Deductible \$ _____

Insuring Company	Policy Number	Policy Limit(s) (\$)	Effective Date (yyyy-mm-dd)	Expiry Date (yyyy-mm-dd)

3. Contractor's Equipment Property Insurance: Deductible \$ _____

 Contractor's tools & equipment , materials & supplies in an amount to reflect the replacement cost.
 Policy includes a Waiver of Subrogation Clause in favour of the City.

Insuring Company	Policy Number	All-Risk Property Limit(s) (\$)	Effective Date (yyyy-mm-dd)	Expiry Date (yyyy-mm-dd)

4. Builder's Risk or Installation Floater - Products, supplies and equipment and/or systems, including boiler and machinery, if applicable, that forms part of the Work. Deductible \$ _____

Identify Policy Type:

Builder's Risk

Installation Floater

The Owner shall be included as an additional insured and a joint loss payee.

Insuring Company	Policy Number	Limit of Coverage (\$)	Effective Date (yyyy-mm-dd)	Expiry Date (yyyy-mm-dd)

5. Other (Specify) _____ . Deductible \$ _____

Insuring Company	Policy Number	Policy Limit(s) (\$)	Effective Date (yyyy-mm-dd)	Expiry Date (yyyy-mm-dd)

6. Other (Specify) _____ . Deductible \$ _____

Insuring Company	Policy Number	Policy Limit(s) (\$)	Effective Date (yyyy-mm-dd)	Expiry Date (yyyy-mm-dd)

All of the above policies (with the exception of the Automobile Insurance, Section 2 above) must include a clause that states that if the policy is cancelled during the period of coverage, as stated herein, thirty (30) days, (fifteen (15) days if cancellation is due to non-payment of premium), prior written notice by registered mail will be given by the Insurer(s) to the Toronto Zoo.

CERTIFICATION

I certify that the insurance is in effect as stated in this Certificate and that I have authorization to issue this Certificate for and on behalf of the Insurer(s). This Certificate is valid until the expiration date(s) stated in the "Expiry Date" provision, unless notice is given in writing in accordance with the provision of this Certificate.

Date	Broker's or Insurer's Name and Address	Signature and Stamp of Certifying Official

FORM 3: TAX STATUTORY DECLARATION

CANADA,) IN THE MATTER OF the annexed Agreement
PROVINCE OF ONTARIO,) made between
JUDICIAL DISTRICT OF YORK)
)
)
)
) – and –
)
) [OWNER]
)
) this ____ day of ____, 20__.
) with respect to
)

I, _____, of the CITY / TOWN / VILLAGE of _____
in the Province of _____, do solemnly declare as follows:

1. I am _____ of _____
(If an incorporated Company, state "President", (Company Name)
"Secretary", or as the case may be)
referred to above (hereinafter called "the Contractor"), and as such have knowledge of
the matters hereinafter declared to.
2. The Contractor has paid all taxes and/or penalties imposed on it by the Corporation Tax
Act, R.S.O. 1990, c. C.40, as may be amended.

AND I MAKE this solemn Declaration conscientiously believing it to be true and knowing that it
is of the same force and effect as if made under oath.

DECLARED before me at _____ }
the _____ of _____ }
in the City of Toronto }
this _____ day } _____
of _____ 20__ } Signing Officer of Company

A Commissioner, etc.

FORM 4: NOTICE OF ADJUDICATION

**IN THE MATTER OF AN ADJUDICATION PURSUANT TO PART II.1 OF THE
CONSTRUCTION ACT, R.S.O. 1990, c. C.30, as amended**

Notice of Adjudication

Date

Agreement Information

Contract Number

Project

Information of Party Initiating the Adjudication

Corporate Name

Corporate Address

City/Town Province Corporate Phone No.

Postal Code Email (if applicable) Corporate Fax No.

Information of Party Receiving the Notice of Adjudication

Corporate Name

Corporate Address

City/Town Province Corporate Phone No.

Postal Code Email (if applicable) Corporate Fax No.

Contractor Information

Contractor Project Manager, if applicable

Contractor Site Supervisor, if applicable

Owner Information

Owner Representative

Contract Administrator

Adjudication Claim Information

Claimed Amount, exclusive H.S.T.

**Construction Agreement
Schedule G – Forms**

Please indicate which Adjudicable Matter the Adjudication is in respect of:

<input type="checkbox"/> Valuation of services or materials provided under the Agreement
<input type="checkbox"/> Payment under the Agreement
<input type="checkbox"/> Dispute regarding a Notice of Non-Payment
<input type="checkbox"/> Amounts Set-off by Owner
<input type="checkbox"/> Non-payment of Lien Holdback

If applicable, please identify relevant:

<input type="checkbox"/> Change Directive Number: _____
<input type="checkbox"/> Change Order Number: _____
<input type="checkbox"/> Proper Invoice Number: _____
<input type="checkbox"/> Claim Notice reference number and date: _____

Please provide the nature and a brief description of the dispute, including details respecting how and when the dispute arose and the nature of the redress sought (attach a separate sheet if necessary):

Requested Adjudicator

First and Last Name		
Address		
City/Town	Province	Phone No.
Postal Code	Website (if applicable)	Email

Consolidation

- The dispute which is the subject matter of this Notice of Adjudication is proposed to be consolidated with the disputes which are the subject matter of the notices of adjudication attached as "**Attachment 1**"

Delivery

See GC 12.2.4 for method of delivery of the Notice of Adjudication and address for delivery.

Attachments

Please attach a copy of any notices of adjudication for adjudications proposed to be consolidated to this Notice of Adjudication as "**Attachment 1**".

Please attach a copy of SCHEDULE A – INFORMATION SHEET to this Notice of Adjudication as "**Attachment 2**".

SCHEDULE H

DRAWINGS AND SPECIFICATIONS

[Note to Finalization before Execution: Attach or list the Drawings and Specifications (which includes, for clarity, the Standard Drawings, the Standard Specifications and Special Specifications and material and finishing schedules).]

PART 3 – DRAWINGS AND SPECIFICATIONS

TZC T 38-2021-10 – RETAINING WALL REPLACEMENT

DRAWING LIST

- Section A-A – Viewing
- Section B-B – Non-Viewing
- Typical Plan Details of Viewing
- Typical Plan Details of Non-Viewing
- Handrail Plan & Elevation
- Ostrich Exhibit Aerial View
- Ostrich Exhibit Plan View
- Site Services Plan

SPECIFICATIONS/SCOPE

- SCOPE

LEGEND:

- COMMUNICATION
- IRRIGATION
- HIGH VOLTAGE
- HYDRO
- WATER
- GAS
- STORM
- SANITARY
- FIBRE OPTICS
- DUCT BANK ROUTING
- ROAD CROSSING/
CONCRETE ENCASED DUCTS
- DIRECTIONAL BORING
- POWER MANHOLE
- COMMUNICATIONS MANHOLE



**361A OLD FINCH AVE.
TORONTO, ON
M1B 5K7**

NO.	DESCRIPTION	DATE
1	FOR ADDENDUM 1	2020.09.10

NO.	REVISIONS	DATE
-----	-----------	------



SITE PLAN

APPROVED BY
NAME:

DATE:

**SITE SERVICES
OSTRICH**

PROJECT #: SITE PLAN

DRAWN BY: D.G.

CHECKED BY:

DATE: 2018.08.24

SCALE: AS SHOWN

DRAWING #:

ST1.02

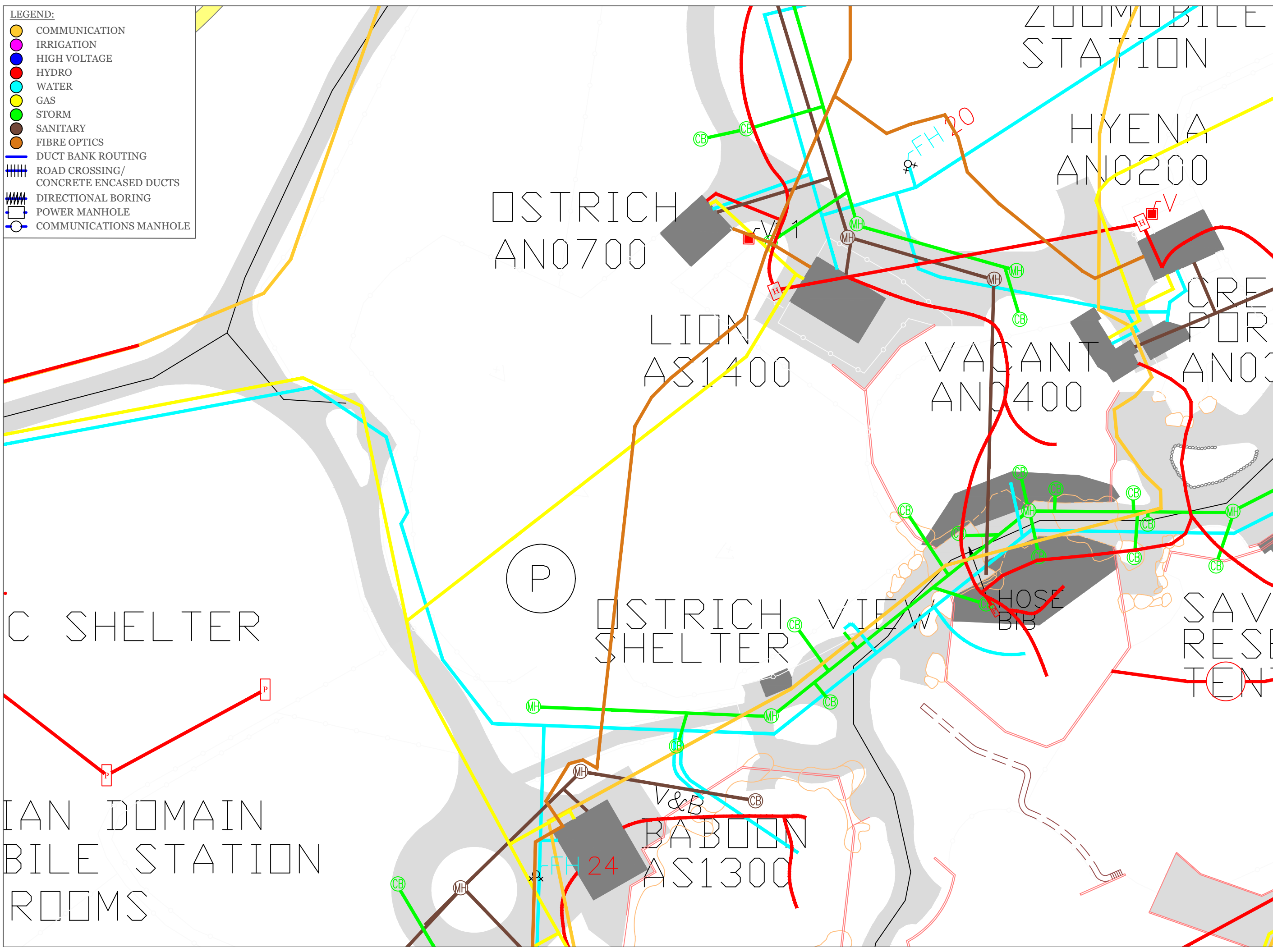

1.0 SCOPE OF WORK

BASE PRICING SCOPE:

1. Supply all labour, tools, materials and equipment to complete the work as outlined in the quotation documents, drawings and specifications.
2. Excavate and remove existing wood:
 - 2.1. Leave existing steel structure in place.
 - 2.2. Excavate in a way as to not damage existing tie-backs
 - 2.3. Brush clearing is the responsibility of the contractor.
 - 2.4. Dispose of all excess fill and brush off site.
3. At all non-viewing areas:
 - 3.1. Extend existing steel structure 2' taller using same sized steel members as existing
 - 3.2. Form and pour 8" thick concrete retaining wall between existing WF beams to 6" above grade
 - 3.2.1. Weld rebar between the existing WF beams as required to reinforce the concrete
 - 3.3. Install timbers the same size as existing between steel structure above grade.
 - 3.4. Backfill as per the original design (drawings attached).
4. At all viewing areas:
 - 4.1. Form and pour 8" thick concrete retaining wall between existing WF beams to 6" above grade
 - 4.1.1. Weld rebar between the existing WF beams as required to reinforce the concrete
 - 4.2. Install timbers the same size as existing between steel structure above grade. Replace viewing rails as per original design (drawings attached).
 - 4.3. Backfill as per the original design (drawings attached).
 - 4.4. Replace cut asphalt with concrete.
5. Contractor is responsible for any required permits and/or engineering.
6. All work to be completed in accordance with applicable codes (e.g. Building Code, Electrical Code, Fire Code, etc.)

Request for Tender
TZC T 38-2021-10 Replacement of Retaining Walls
Part 3 – Scope

7. Any work must be carefully coordinated with the Zoo to ensure the safety of guests, staff and the animals.
8. Overhead work shall be performed using appropriate barricades to prevent people from inadvertently walking below the work.
9. Any equipment parked on service roads or public pathways shall be completely surrounded by appropriate barricades to prevent unauthorized personnel from entering the area.
10. Any required barricades shall be supplied and installed by the successful bidder.
11. The contractor shall supply the Zoo with copies of relevant certificates and licences for all workers prior to commencement of work.
 - 11.1. Use only CWB certified welders for welding work.
12. All measurements to be site verified.
13. Utility Locates will be performed and provided by the Toronto Zoo.
14. The contractor is required to provide closeout documents including but not limited to as built drawings, warranty, and inspection certificates.

2.0 CONTRACTOR RESPONSIBILITIES

1. Regular meetings/communication with the Toronto Zoo Project Team to review project status and to discuss issues that may arise during the project.
2. Provide samples, mock-ups, etc. as required to the Project Team. A sample for the mud bank finish is required, prior to complete application. Sample is to be approved by the Toronto Zoo.
3. Provide product information, SDS sheets and colour samples to the Project Team prior to start of the work where applicable.
4. Protect adjacent areas not included in the project. Any damage caused will be the responsibility of the contractor to rectify at no additional cost to the Zoo.
5. Clean the work area and remove all debris from site on a daily basis and make good any damage caused as a result of the work.
6. Secure the work site and provide construction signs and barriers to prevent injury to Zoo personnel and the public who will require access to the surrounding space during the work.
7. All electric current required for the work shall be provided or furnished by the Contractor. All temporary connections for electricity shall be subject to the approval of the Owner. All temporary lines will be furnished, installed, connected, and maintained by the Contractor in a professional manner satisfactory to the Owner and shall be removed by the Contractor in like manner upon completion of the work.

8. Upon award of contract, Contractor is to finish all work, including clean up and demobilization by the completion date specified.
9. Submit all shop drawings for review and approval prior to start of fabrication. Review of shop drawings shall not mean that the Toronto Zoo approves detail design inherent in shop drawings, responsibility for which shall remain with the Contractor submitting same, and such review shall not relieve the Contractor of his responsibility for errors or omissions in shop drawings or of his responsibility for meeting all requirements of the subcontract documents.
10. Submit close out documents as requested. Include warranties and “As built” drawings.

3.0 SAFETY SPECIFICATIONS

1. It is the responsibility of the Contractor to protect the site as required during construction.
2. Ensure that awareness of public safety is considered and protect visitors in the vicinity during the construction period.
3. All necessary personal protective equipment must be worn at all times and SDS sheets must be available on site as required.
4. It is the responsibility of the Contractor to ensure that the work site is properly protected at all times. All work sites must be marked and hoarded adequately with construction signs posted to secure and isolate the work site from the public or other personnel that have access to the area.

SEE DWG. ZX-17B
FOR CONTINUATION OF FENCE

~~PATAS MARKET AND STANT ELAND SHELTER
(SEE ARCHITECTURAL DWGS. FOR DETAILS)~~ (3'-0" GATE)

PRIME VIEWING AREA

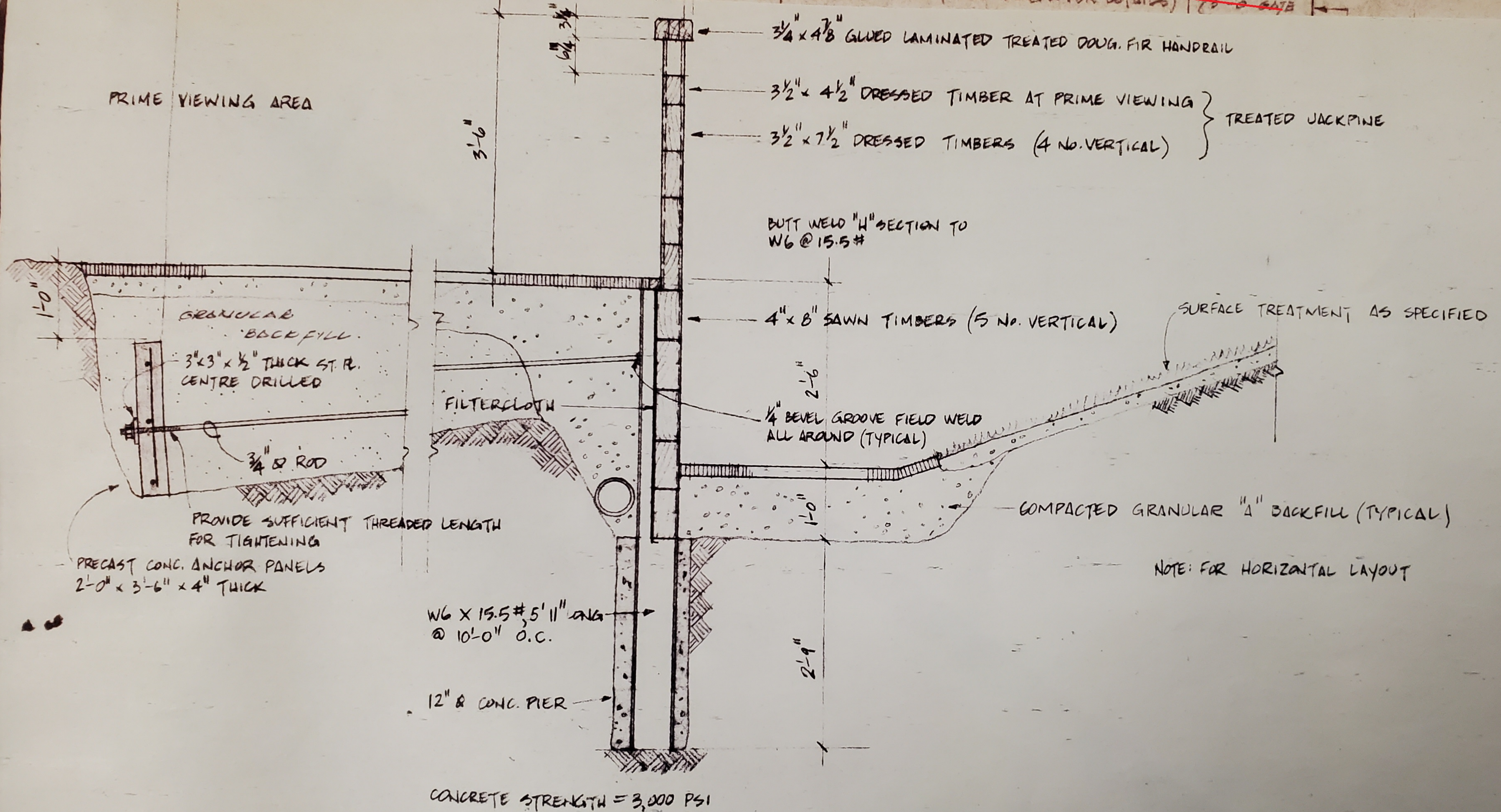

GRANULAR BACKFILL

3"x3"x 1/2" THICK ST. PL. CENTRE DRILLED

3/4" Ø ROD

PROVIDE SUFFICIENT THREADED LENGTH FOR TIGHTENING

PRECAST CONC. ANCHOR PANELS 2'-0" x 3'-6" x 4" THICK

W6 X 15.5 #, 5" 11" ANGLE @ 10'-0" O.C.

12" Ø CONC. PIER

CONCRETE STRENGTH = 3,000 PSI

SECTION "A - A" (SEE DWG'S. ZX12B, 13B, 17B & 18B FOR PLANS)
 Scale: 1" = 2'-0"

~~SEE GRADING PLAN FOR FINISHED SURFACE PROFILE~~ 11'-0"

~~TOPSOIL GRASS SEED OR SOD (TYPICAL)~~

CONCRETE STRENGTH = 3,000 PSI

SECTION "A - A" (SEE DWGS. ZX12B, 13B, 17B & 18B FOR PLANS)

Scale 1" = 2' - 0"



SECTION "B - B" (SEE DWGS. ZX12B, 13B, 17B & 18B FOR PLANS)

Scale 1" = 4' - 0"

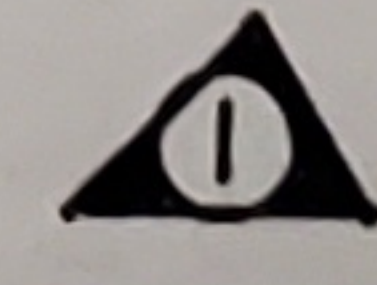

SECTION B-B - NON-VIEWING

~~EXHIBIT AREA~~
~~BUTT WELD UPPER "H" SECTION TO W6 @ 15.5 STEEL PILE~~

~~EXHIBIT AREA~~
~~SMOOTH NEAT JOINT (TYPICAL)~~
~~NO LIPS ALLOWED~~
~~1/4" x 6" STEEL PLATE, 3'-4 3/4" LONG~~

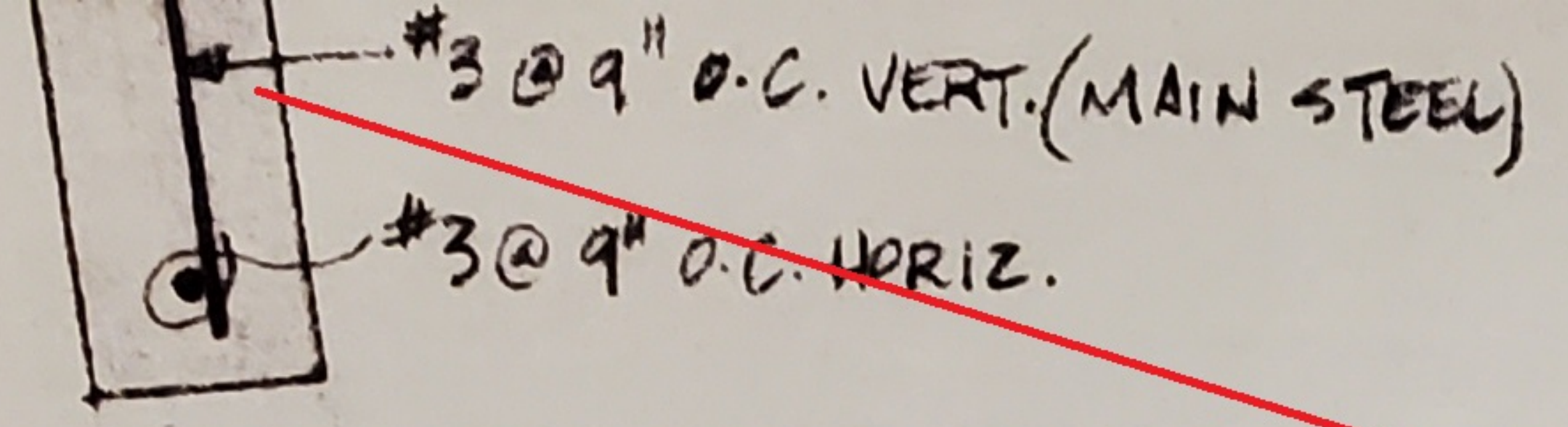

STEEL PILE W6 @ 15.5#
8'-9" LONG @ 10'-0" O.C.

SECTION "B - B" (SEE DWG'S ZX12B, 13B, 17B & 18B FOR PLANS)

Scale 1" = 4' - 0"

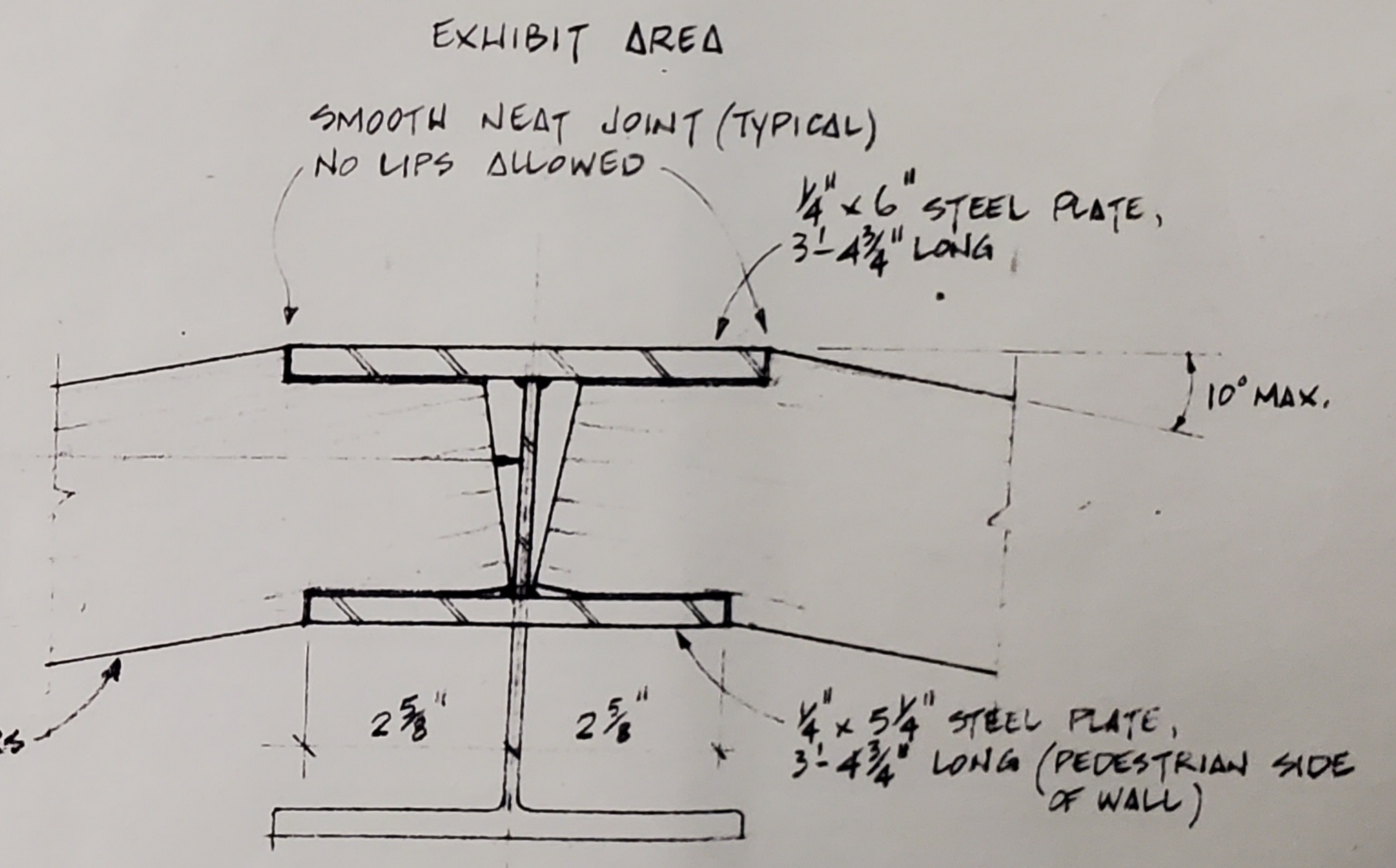
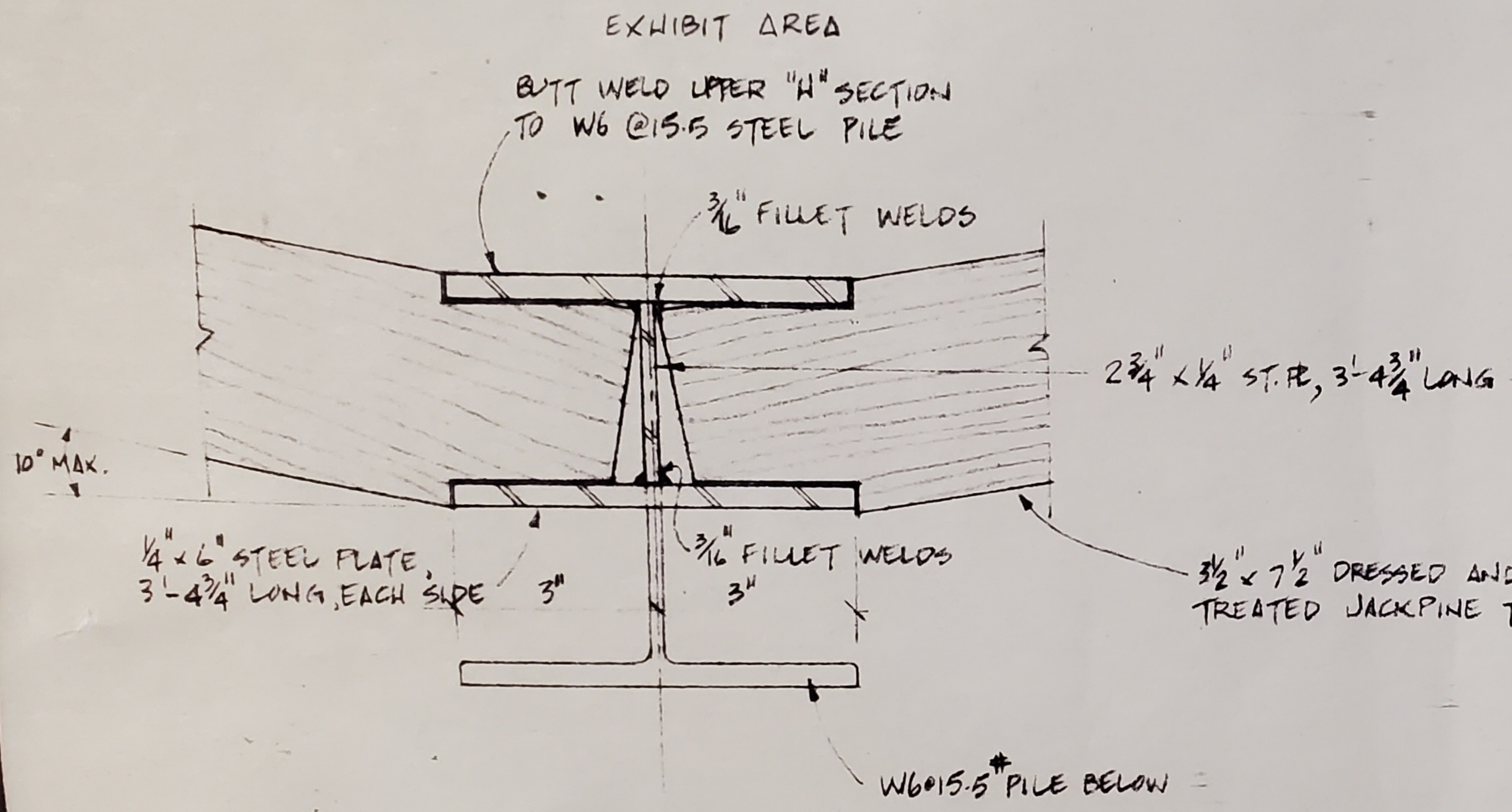

TYPICAL PLAN DETAILS (SEE SECTION "A-A")

Scale 3" = 1' - 0"

TYPICAL PLAN DETAILS - VIEWING

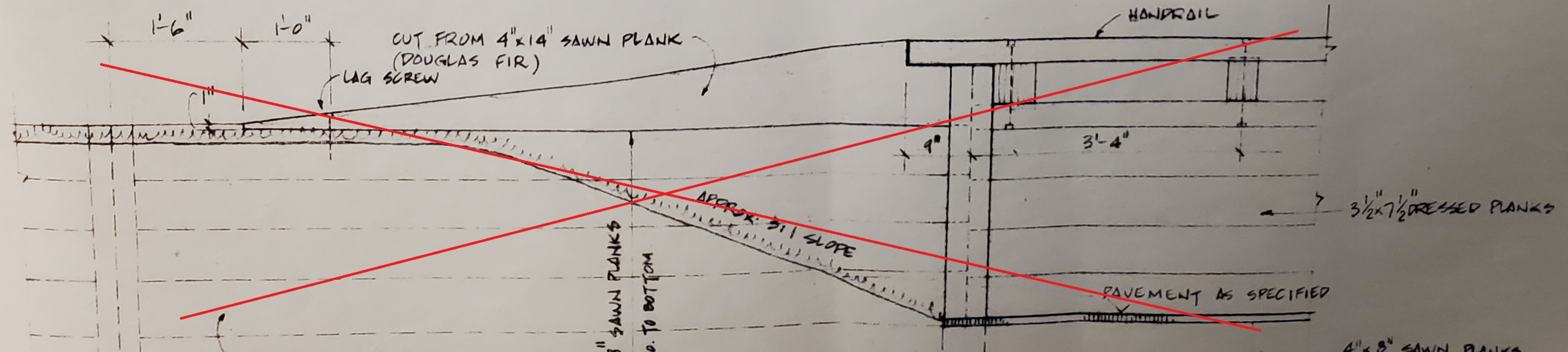

W6 X 15.5# 8'-9" LONG
@ 10'-0" O.C.

SECTION "C - C" (SEE DWGS ZY 17B & 18B FOR PLANS)

Scale 1" = 4' - 0"

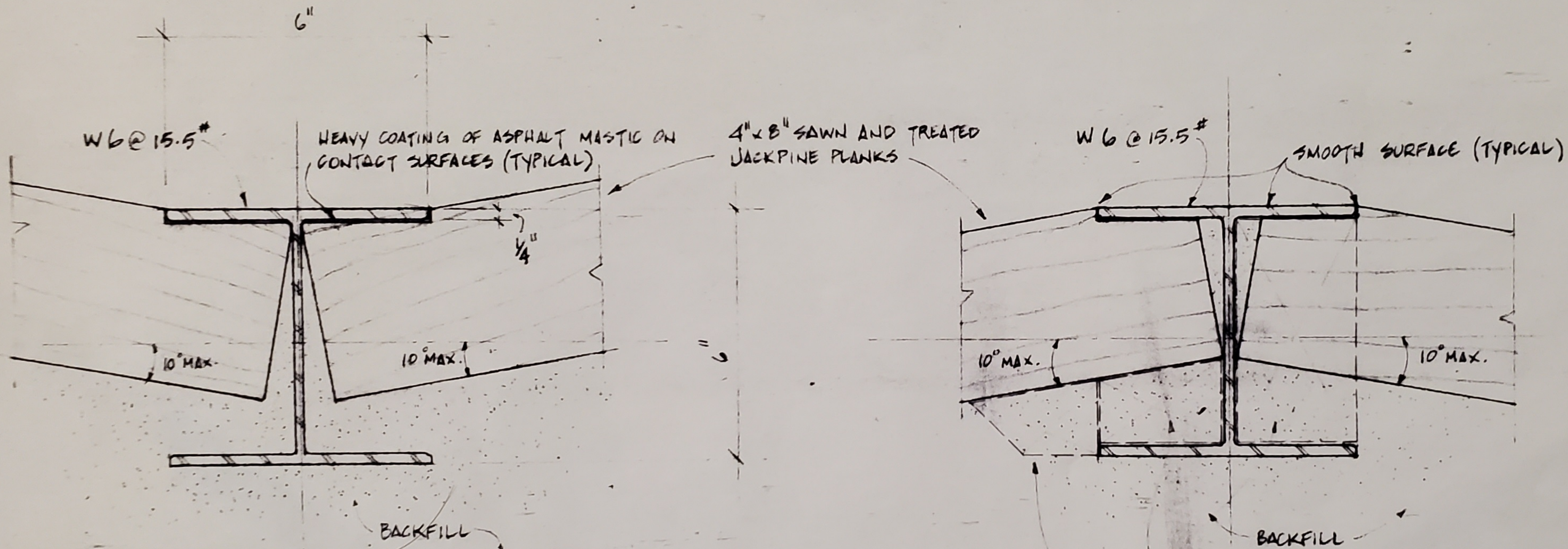

TREATED TIMBER BLOCKING AT END POSTS
NAILED AND BOLTED IN POSITION
ADDITIONAL BLOCKING AT END POSTS FOR SECTIONS "C-C" AND "D-D"
(ALL CONTACT FACES TO BE COATED WITH ASPHALT MASTIC)

TYPICAL PLAN DETAILS (SEE SECTION "B-B")

Scale 3" = 1' - 0"

TYPICAL PLAN DETAILS - NON-VIEWING

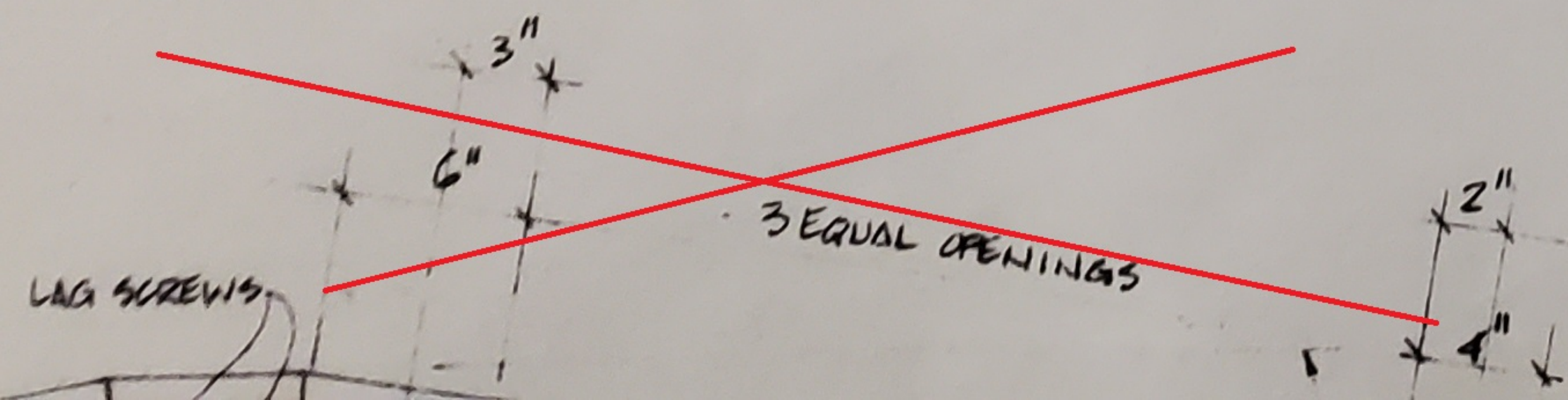

~~6" STEEL PLATE,
1/4" LONG~~

~~10° MAX.~~

~~5 1/4" STEEL PLATE,
4 3/4" LONG (PEDESTRIAN SIDE
OF WALL)~~

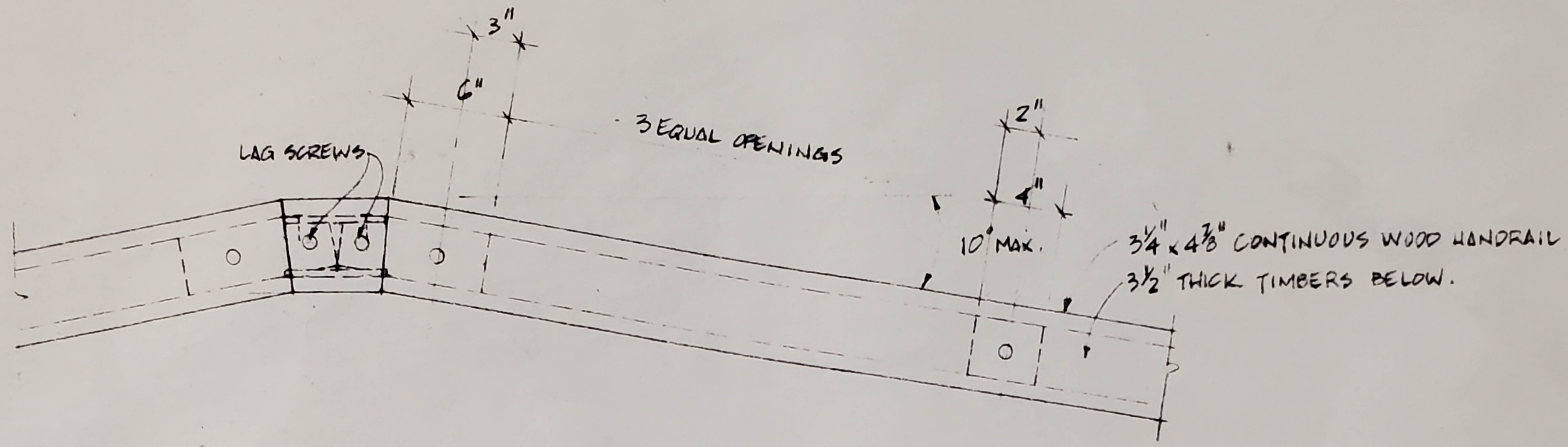

PLAN - HANDRAIL

Scale 1" = 1' - 0"

NOTE: ALL EXPOSED TIMBER TOP EDGES
TO BE ROUNDED (1/4" RADIUS)

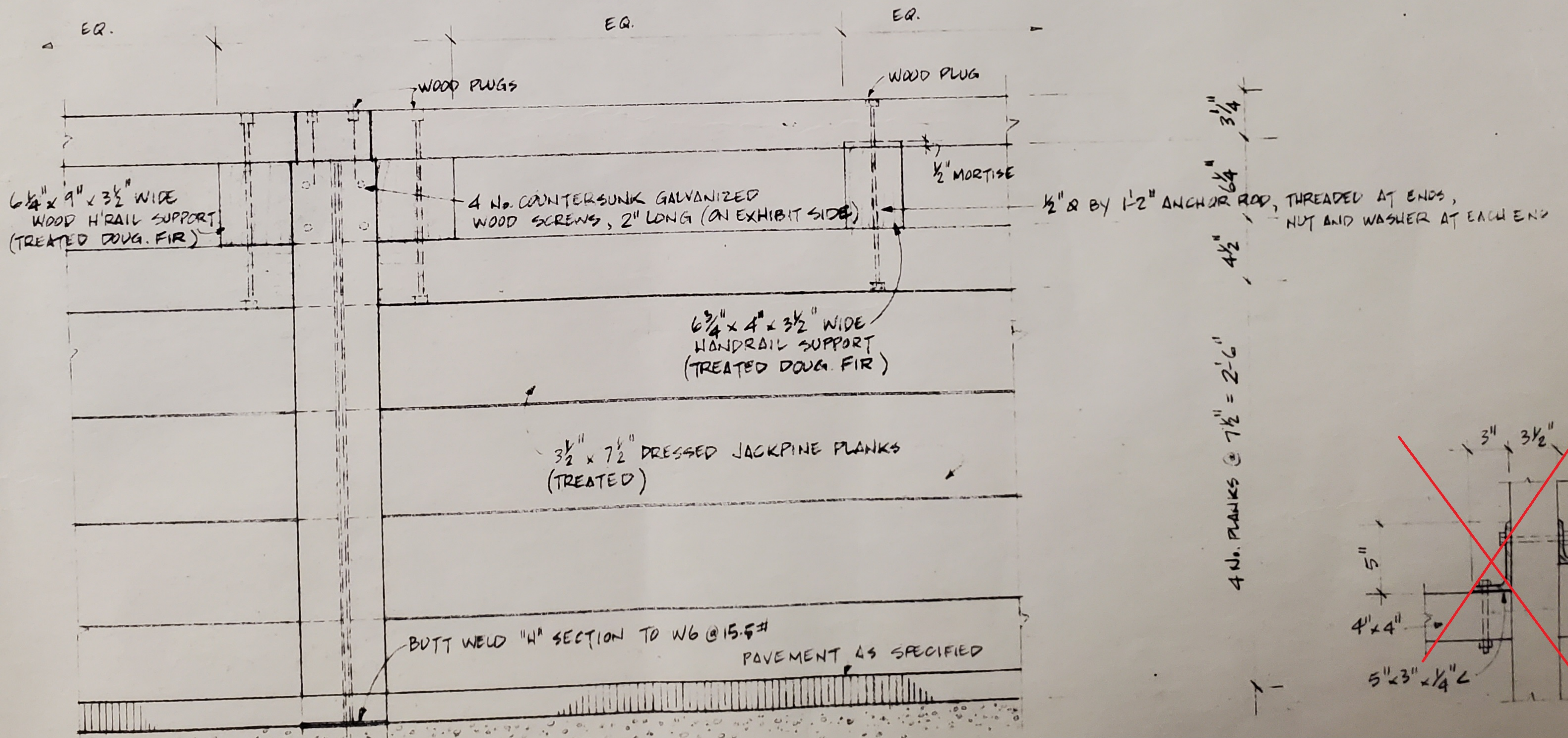

~~3 1/2 x 7 1/2 DRESSED PLANKS~~

~~4 x 8 SAWN PLANKS
(5 No. TO BOTTOM)~~

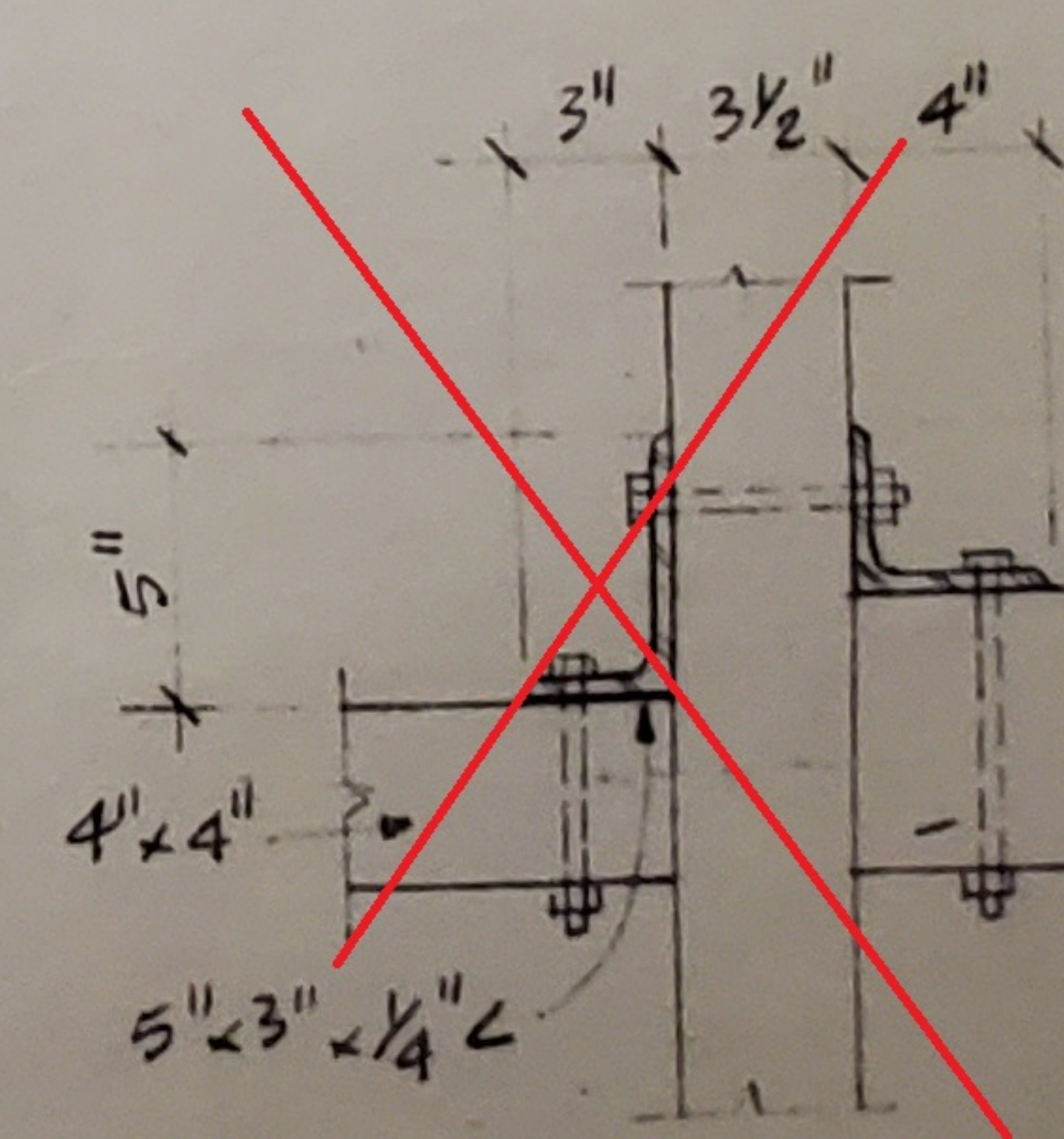

ELEVATION - HANDRAIL

Scale 1" = 1' - 0"

HANDRAIL PLAN & ELEVATION

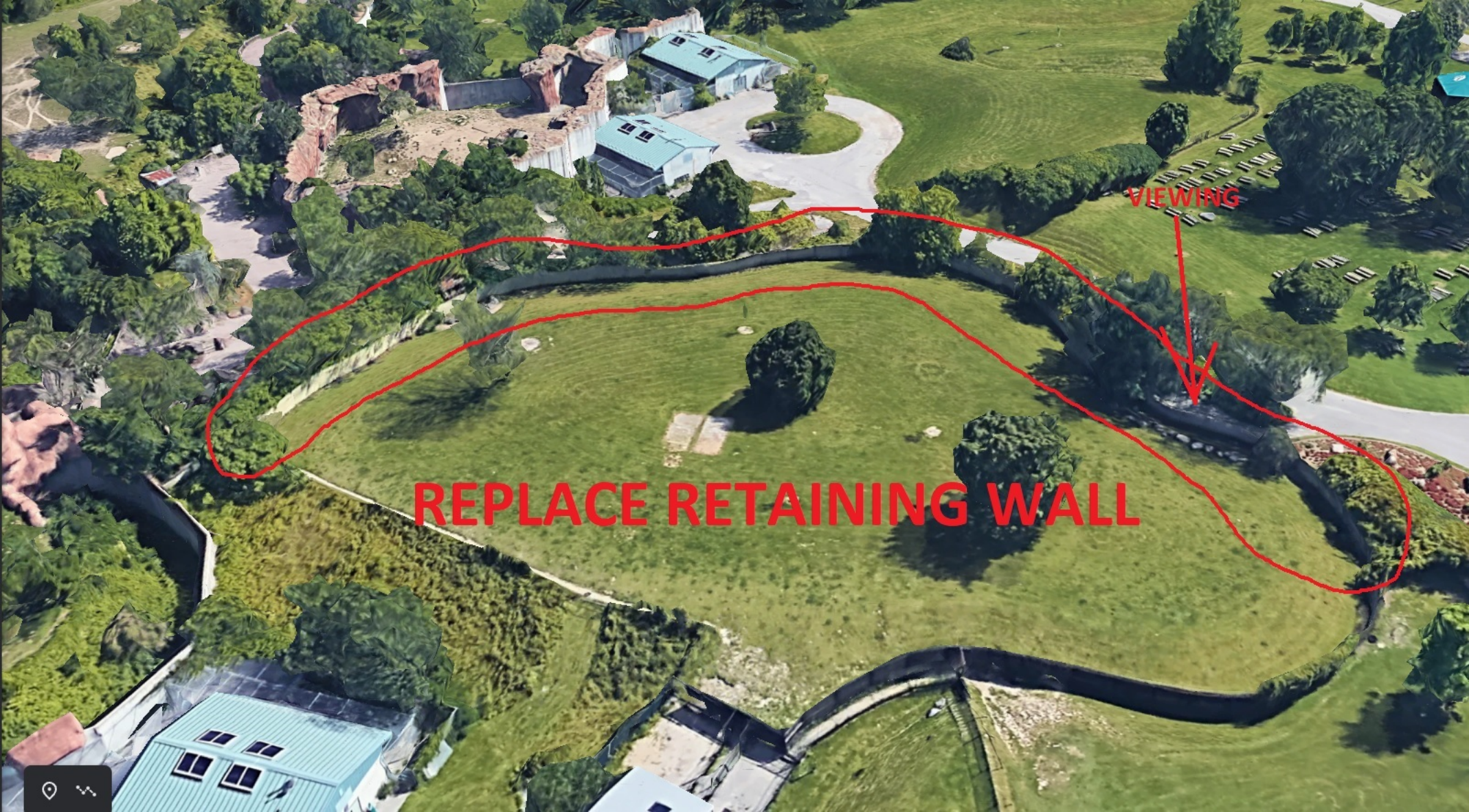

REPLACE RETAINING WALL

VIEWING





**440' OF NON-VIEWING
RETAINING WALL**

**40' OF VIEWING AREA
RETAINING WALL**

PART 4 Bid Submission Form

1. Supplier Information

Please fill out the following information, naming one individual to be the Supplier's contact for the RFT process and for any clarifications or communication that might be necessary.	
Full Legal Name of Supplier:	
Any Other Relevant Name under which Supplier Carries on Business:	
Street Address:	
City, Province/State:	
Postal Code:	
Phone Number:	
Fax Number:	
Company Website (if any):	
Supplier Contact Name and Title:	
Supplier Contact Phone:	
Supplier Contact Fax:	
Supplier Contact Email:	

2. Acknowledgment of Binding Procurement Process

The Supplier:

- (a) acknowledges and agrees that the RFT process will be governed by the terms and conditions of the RFT and the Toronto Zoo's Policies and Legislation;
- (b) hereby confirms it has read and understand such terms and conditions;
- (c) hereby confirms its compliance with such terms and conditions; and
- (d) hereby confirms it has submitted a Bid Bond with your submission The Supplier further acknowledges and agrees that its Bid will remain legally binding for the Bid Validity Period, or if the Supplier is selected, as the Successful Supplier, until the Supplier executes a written Contract for the Work and furnishes all other documents required by Part 1 - Section 2.3.2 (Contract Execution).

3. Ability to Provide Work

The Supplier has carefully examined the RFT documents and has a clear and comprehensive knowledge of the Work required. The Supplier represents and warrants its ability to provide the Work in accordance with the requirements of the RFT for the pricing set out in the Pricing Form completed by the Supplier.



4. Binding Pricing

The Supplier has submitted its pricing in accordance with the instructions in the RFT and in the Pricing Form. The Supplier confirms that the pricing information provided is accurate and binding for the Bid Validity Period. The Supplier acknowledges that any inaccurate, misleading or incomplete information, including withdrawn or altered pricing, could adversely impact the acceptance of its Bid, the forfeiture of its Bid Bond, or its eligibility for future work.

5. Addenda

The Supplier acknowledges all Addenda issued by the Toronto Zoo prior to the Deadline for Issuing Addenda set out in the RFT timetable in Part 1 - Section 1.5 (RFT Timetable) in accordance with Part 1 – 1.7 (Addenda).

6. The Toronto Zoo Policies

The Supplier has read, understood and agrees to comply with the Toronto Zoo’s Policies.

Without limiting the Supplier’s acknowledgement of the Policies, the Supplier makes the following declarations and agrees to provide the Toronto Zoo with ongoing disclosure of any changes to the declarations and information provided below during the RFT process or the term of any contract. The Supplier shall provide the City with ongoing disclosure, should the Supplier be awarded the Contract and any of the information declared below changes.

(i) Collusion and Unethical Bidding

If the Supplier declares an affiliation or other relationship with other Suppliers that might be seen to compromise the principle of fair competition, the Supplier must set out the details below. If no details are provided, the Supplier is deemed to declare that it has no such affiliation or relationship.

(ii) Illegality

If the Supplier declares any previous convictions of itself or its Affiliated Persons for collusion, Bid-rigging, price-fixing, bribery, fraud or other similar behaviours or practices prohibited under the *Criminal Code*, the *Competition Act* or other applicable law, for which they have not received a pardon, the Supplier must set out the details below. If no details are provided, the Supplier is deemed to declare that it or its Affiliated Persons have no such convictions.

(iii) Conflicts of Interest or Unfair Advantage

Potential Conflicts of Interest and unfair advantages include:

- (A) engaging current or former Toronto Zoo employees or public office holders to take any part in the preparation of the Bid or the performance of the contract if awarded, any time within two (2) years of such individuals having left the employ or public office of the Toronto Zoo;
- (B) engaging any family members, friends or private business associates of any public office holder which may have, or appear to have, any influence on the procurement process, or subsequent performance of the contract;
- (C) prior involvement by the Supplier or Affiliated Persons in developing the technical specifications or other evaluation criteria for the RFT;
- (D) prior access to confidential Toronto Zoo information by the Supplier, or Affiliated Persons, that is materially related to the RFT and that was not readily accessible to other prospective Suppliers; or
- (E) the Supplier or its Affiliated Persons are indebted to or engaged in ongoing or proposed litigation with the Toronto Zoo in relation to a previous contract.



TZC T 38-2021-10 RETAINING WALL REPLACEMENT
PART 4- SUBMISSION FORMS

For the purposes of section (A) above, Suppliers must disclose the names of all individuals (employees, advisers, or individuals acting in any other capacity) who (a) were employees of the Toronto Zoo within twenty-four (24) months prior to the Submission Deadline; and (b) disclose all pertinent details including whether such former Toronto Zoo employees participated in the preparation of the Bid or will participate in the performance of the contract if awarded to the Supplier.

If the Supplier declares an actual or potential Conflict of Interest or unfair advantage, the Supplier must set out details of the actual or potential Conflict of Interest below. If no details are provided, the Supplier is deemed to declare that it has no actual or potential conflict of interest or unfair advantage.

(b) **Declaration of Compliance with Anti-Harassment/Discrimination Policy**

Organizations/individuals in Ontario, including the Toronto Zoo, have obligations under the *Ontario Human Rights Code*, the *Occupational Health and Safety Act*, the *Employment Standards Act*, the *Accessibility for Ontarians with Disabilities Act*, the *Criminal Code* and the *Charter of Rights and Freedoms*.

7. The following irregularities contained in bids such as quotation, tenders or proposal ("Response") received by the Toronto Zoo shall result in the following actions:

IRREGULARITIES	ACTION
Late Response	Automatic rejection and not read publicly.
Unsealed Envelopes	Automatic rejection.

Insufficient Financial Security (No deposit or bid bond or agreement to bond or insufficient deposit or bid bond or agreement to bond).	Automatic rejection.
Response not completed in non-erasable medium and signed in ink.	Automatic rejection.
Incomplete Response	Automatic rejection unless, in the opinion of the Purchasing Agent, the incomplete nature is trivial or insignificant.
Qualified Response (qualified or restricted by an attached statement, unless allowed for), the qualification or restriction is trivial or not significant.	Automatic rejection unless, in the opinion of the Purchasing Agent the incomplete nature is trivial or insignificant.
Response received on documents other than those provided by the Toronto Zoo.	Automatic rejection unless, in the opinion of the Purchasing Agent, the matter is trivial or insignificant.
Execution of Bid Bond (Financial Security) - Corporate Seal or signature of bidder missing. - Both corporate seal and signature of the bidder missing. Corporate seal or signature of authorized agents of bonding company missing.	Two (2) business days to correct. Automatic rejection. Automatic rejection.
Other Bid Security – Uncertified Cheque	Automatic rejection.
Documents – Execution - Corporate seal or signature missing. - Corporate seal and signature missing.	Two (2) business days to correct. Automatic rejection.
Erasures, Overwriting or Strike-Outs which are not Initialed: Uninitialed changes to response which are minor (example: the respondent’s address is amended by over-writing but not initialed). Unit prices have been changed but not initialed and the contract totals are consistent with the price as amended. Unit prices have been changed but not initialed and the contract totals are not consistent with the price as amended.	Two (2) business days to initial. Two (2) business days to initial. Automatic rejection.



**TZC T 38-2021-10 RETAINING WALL REPLACEMENT
PART 4- SUBMISSION FORMS**

Minor Irregularities	The Purchasing Agent shall have the authority to waive irregularities deemed to be minor.
----------------------	---

(a) **Declaration of Compliance with the City’s Fair Wage** By completing this Bid Submission Form, the Supplier declares that the Supplier and its proposed Subcontractors agree to abide by the City’s as applicable.

(b) **Declaration of Compliance with Accessible Customer Service Training Requirements**

By completing this Bid Submission Form, the Supplier declares that the Supplier and its proposed Subcontractors agree to comply with the Toronto Zoo’s [Accessible Customer Service Training Requirements](#).

YES _____ NO _____

If yes, the Supplier confirms the following brief statement of the environmental benefit of the product/service:

(c) **The Toronto Zoo Contractor Performance Evaluation**

The Toronto Zoo follows a Contractor Performance Evaluation procedure which provides guidance to Toronto Zoo staff on creating and maintaining an evaluative record of a Contractor’s performance on Toronto Zoo projects for the purpose of Contract management and future purchasing decisions.

(d) **Disclosure of Information**

The Supplier hereby agrees that any information provided in this Bid, even if it is identified as being supplied in confidence, may be disclosed in accordance with the terms or the RFT or where required by law or by order of a court or tribunal.



APPENDIX I - PROJECT EXPERIENCE FORM

The bid must include Project Experience Form(s). Please include details of a minimum of three (3) and no more than five (5) projects within the last five (5) years where the bidder was the lead contractor and the work was similar in scope and/or size as the project described in the Bid Documents. **Do not include the Toronto Zoo as a named reference.**

Project/Contract:	
Start Date:	End Date:
Completed on Schedule: Yes or No	
Contract Value (CDN dollars)	\$
Owner:	
Address/Location:	
Names of Key Personnel assigned and Subcontractors	
PROJECT DETAILS: Scope of the Work, Contingency Planning, Challenges Overcome, electrical, mechanical, structural, access to materials, e.g. project management, etc.:	
REFERENCE: Name, Title, Telephone, Email	

APPENDIX II – LIST OF SUBCONTRACTORS FORM

Pursuant to Section 1.9.5 (List of Subcontractors Form), the Supplier shall provide each Subcontractor’s and the Work type the Subcontractor is expected to perform in the table below or indicate “OWN FORCES” in the “Subcontractor Name” column if a Subcontractor will not be used for the Work type indicated. The names of all Subcontractors to be used for each Work type indicated must be provided.

The Supplier submits that in proposing the under mentioned subcontractors, the Supplier has consulted each and have ascertained to our completed satisfaction that those names are fully acquainted with the extent and nature of the work and that they will execute their work with the requirements of the contract documents. The Toronto Zoo reserves the right to accept or reject any sub-contractor or persons named below.

Work or Services to be Performed	Name/Address	Company Contact & Tel #	Licence #	% of overall of Work to be performed by the Sub-Contractor



**TZC T 38-2021-10 RETAINING WALL REPLACEMENT
PART 4- SUBMISSION FORMS**

APPENDIX III - STATUTORY DECLARATION OF TENDERER

STATUTORY DECLARATION OF TENDERER

CANADA) IN THE MATTER of a Tender by*
 PROVINCE OF ONTARIO)
 JUDICIAL DISTRICT OF YORK) for
)
) RETAINING WALL REPLACEMENT
 TO WIT:) **TZC T 38-2021-10**
)
)

**I/We _____ the _____
 _____ in the _____ of _____

DO SOLEMNLY DECLARE as follows:

If Tenderer is a corporation, **complete 1A** and strike out 1B and 1C.

If Tenderer is an individual carrying on business under firm name, **complete 1B** and strike out 1A and 1C.

If Tenderer is a partnership, **complete 1C** and strike out 1A and 1B

-) 1A. I am (state "President", "Secretary", or
-) as the case may be)
-)
-) of the Tenderer above referred to.
-) _____
-)
-) 1B. I am the Tenderer above referred to,
-) and there is no other person
-) associated with me in partnership.
-)
-) 1C. We are the Tenderers herein carrying on
-) business in Partnership, under the name of
-) _____
-)
-) and we are the only members of such
-) partnership.
-)
-)



TZC T 38-2021-10 RETAINING WALL REPLACEMENT
PART 4– SUBMISSION FORMS

I/We have carefully read through the attached Tender Form and to the best of my/our information, knowledge and belief the several matters stated in the said Form are in all respects correct and true.

-
- * Insert Tenderer's name
 - ** Delete inapplicable word

3. *I AM/WE ARE, each of the full age of eighteen years or over.

*AND I/WE make this solemn declaration conscientiously believing it to be true, and knowing that it is of the same force and effect as if made under oath.

*(SEVERALLY) DECLARED before me)
)
 at the of)
 in the)
)
 this day of , 2021.)
)
)

A Commissioner, etc.

NOTE:

This Declaration must be sworn before a Notary Public or other Commissioner for Oaths.

-
- * Delete inapplicable word



**TZC T 38-2021-10 RETAINING WALL REPLACEMENT
PART 4- SUBMISSION FORMS**

APPENDIX IV - BID BOND

Bond No. _____

Amount: 10% of net contract amount

KNOW ALL MEN BY THESE PRESENTS, that

as Principal, hereinafter called "the Principal", and

as Surety, hereinafter called the Surety, are held and firmly bound unto the Board of Management of the Toronto Zoo as Obligee, each in the amount of

Dollars (\$ _____) lawful money of Canada, for the payment of which sum, well and truly to be made, the Principal and the Surety bind themselves, their heirs, executors, administrators, successors and assigns, jointly and severally, firmly by these presents.

WHEREAS the Principal submitted a written Tender (hereinafter called "the Tender") to the Obligee dated the _____ day of _____, 20____, for _____ at _____ in the _____ in the City of Toronto (hereinafter called "the Work"),

NOW THEREFORE THE CONDITION OF THIS OBLIGATION is such that if, on acceptance of the Tender in accordance with the terms and conditions of the Tender within 90 days from the closing date of the call for Tenders, the Principal shall, within the time required, enter into a formal contract and give good and sufficient bonds to secure the performance of the Work under the terms and conditions of the contract and the payment of its obligations thereunder for all labour, materials and services used or reasonably required for use in the performance of same, then this obligation shall be null and void; otherwise the Principal and Surety will pay unto the Obligee the difference in money between the amount of the price set out in the Tender and the amount for which the Obligee legally contracts with another party to perform the Work if the latter amount be in excess of the former.

The Surety shall not be liable for a greater sum than the specified penalty of this Bond. Any suit under this Bond must be instituted before the expiration of six months from the date of this Bond.

AND IT IS HEREBY DECLARED AND AGREED that the Surety shall be liable as principal and that nothing of any kind or matter whatsoever that will not discharge the Principal, shall operate as a discharge or release of liability of the Surety, any law or usage relating to the liability of sureties to the contrary notwithstanding.

IN TESTIMONY WHEREOF, the Principal has duly executed these presents under seal, and the Surety has caused these presents to be seated with its corporate seal duly attested by the signatures of its duly authorized officers, this _____ day of _____, A.D. 2020.

SIGNED, SEALED AND DELIVERED) *
in the presence of:)
)



TZC T 38-2021-10 RETAINING WALL REPLACEMENT
PART 4- SUBMISSION FORMS

)
)
)
) _____
)
)
)
)
)
) _____
) **
)
)
)
) _____
)
)
)
)
)
)
) _____

NOTE:

The NOTE on the signing page of the Tender Form applies equally to execution of this Bond.

- * Type or print name of Principal here
- ** Type name of Surety here



TZC T 38-2021-10 RETAINING WALL REPLACEMENT
PART 4- SUBMISSION FORMS

APPENDIX V - AGREEMENT TO BOND

(to be attached to and to form part of Bid Bond)

We, the undersigned, the Surety on the attached Bid Bond hereby undertake and agree with the Board of Management of the Toronto Zoo as Obligee if our Principal's Tender is accepted by you to become bound as Surety for our Principal

(Name of Tenderer)

of _____

(Place)

the Tenderer to you by Tender Form dated _____

for _____

(hereinafter _____)

(Description of work)
(called "the Work")

in an amount equal to Fifty Per Cent (50%) of the Contract Price for the due and proper performance of the Work as shown and described in the Contract between the Obligee and our Principal for the Work, including a period of maintenance of one (1) year after the final completion of the Work and, in addition, in an equal amount for the due and proper payment of those having direct contracts with our Principal for labour, material and/or services for the Contract Work, removal of registered lien claims and certificates of action from the title to the lands on which the Work is performed and full reimbursement of the Obligee for all liability and payments to such persons in connection with the Contract, such performance and payment bonds both to be in the forms indicated by the Obligee in the Tender documents.

It is a condition that this Agreement shall become null and void if the bonds mentioned above are not required from our Principal within ninety (90) days of the award of the Contract to our Principal.

In witness whereof we have hereunto affixed our Corporate Seal, testified by the hand(s) of the proper officer in that behalf.

Dated this _____ day of _____, 2020.

(name of Surety)

(Address of Local Office)

**TZC T 38-2021-10 RETAINING WALL REPLACEMENT
PART 5- PRICING FORMS**

Tender Pricing Form Submission

Complete and return this section Part 4–*Form of Tender* including Appendices I to XII

Project/Contract: RETAINING WALL REPLACEMENT

Project/Contract No.: TZC T 38-2021-10

OWNER: TORONTO ZOO

I/We, the undersigned have received, allowed for and included as part of our submission all issued Addendum numbered _____.

This form must be completed, properly signed and received on or before the date and time specified or your submission will not be considered. Quoted prices shall remain in effect for a period of ninety (90) days from the stipulated closing date.

The Board of Management of the Toronto Zoo reserves the right to reject any or all Quotations or to accept any Quotation, should it deem such action to be in its interests.

By signing and submitting this FORM, you are agreeing to the release of your quotation information, as deemed necessary by the Board, in order to conduct business associated with this quotation or project.

I/We, the undersigned, **having the authority to bind the Company**, certify, that I/we have examined the Instruction to Bidders, Construction Agreement and General Conditions, Specifications, Scope of Work, Drawings and Form of Tender, do hereby offer and agree to enter into an agreement with The Toronto Zoo, to install electric vehicle charging stations as described herein for a Total Tender Price, including HST in Canadian funds, equal to the total of the amounts in the following clauses (A) to (B).

THIS TENDER is submitted by

PLEASE
USE INK

Name of Firm

Address

Postal Code

Telephone Number

Fax Number



**TZC T 38-2021-10 RETAINING WALL REPLACEMENT
PART 5- PRICING FORMS**

2020-10-27

Name of Authorized Signing Officer for Firm

Title of Authorized Signing Officer for Firm

Name and Title of Project Contact Person

Email and fax # of Project Contact person

**TZC T 38-2021-10 RETAINING WALL REPLACEMENT
PART 5- PRICING FORMS**

FORM OF TOTAL TENDER PRICE

(A) PRICE of TENDER, which excludes HST is:

_____ In lawful money of Canada. (State in writing)

\$ _____
(State in numbers)

**(B) PRICE of HST of (13 %) payable by the Owner to the Contractor
DOLLARS**

_____ In lawful money of Canada. (State in writing)

\$ _____
(State in numbers)

**TOTAL TENDER PRICE, which includes the Tender (A) and HST (B) price is:
DOLLARS**

_____ In lawful money of Canada. (State in writing)

\$ _____
(State in numbers)

DISCOUNT	Discount and/or Other	Days
Discount allowed for prompt payment and period within which invoice must be paid to qualify.	%	
Charity Status: The Toronto Zoo is a registered charitable organization (registration #BN 119216398RR0001) and accordingly may be eligible for preferred pricing which should be reflected in the Quotation as submitted.		

**TZC T 38-2021-10 RETAINING WALL REPLACEMENT
PART 5– PRICING FORMS**

The following appendix(s) must be completed and returned with the tender submission. (“Not applicable” indicated where completion of a section is not required.)

Appendix I	Schedule of Values
Appendix II	Unit Prices
Appendix III	Additional Prices – Not Applicable
Appendix IV	Alternative Prices – Not Applicable
Appendix V	Unsolicited Prices

**TZC T 38-2021-10 RETAINING WALL REPLACEMENT
PART 5- PRICING FORMS**

APPENDIX I- SCHEDULE OF VALUES (Due 24 hours after stipulated closing date)

(**included** in Total Tender Price)

All prices are to include the supply and installation of all labour, material, taxes (excluding Harmonized Sales Tax), charges, payroll, burden, and profit, and would be deducted from the Tender Tender Price should the specified work be excluded from the contract work.

ITEM	DESCRIPTION	PRICE
------	-------------	-------

1.	Mobilization	\$
2.	Excavation including required disposal	\$
3.	Viewing Area	
a.	Removal of existing timbers including disposal	\$
b.	Form and pour concrete retaining wall including reinforcement	\$
c.	Concrete paving at viewing	\$
d.	Construct new viewing barrier	\$
4.	Non-Viewing Areas	
a.	Removal of existing timbers including disposal	\$
b.	Extend steel at non-viewing areas	\$
c.	Form and pour concrete retaining wall including reinforcement	\$
d.	Install new timbers	\$
5.	Backfill	
6.	Demobilization	\$
	Total Bulk Tender Price*	\$

**TZC T 38-2021-10 RETAINING WALL REPLACEMENT
PART 5- PRICING FORMS**

*The sum of the amounts shown in the table above **should** equal the Total Tender Price stipulated in the space provided in the Form of Total Tender Price

**TZC T 38-2021-10 RETAINING WALL REPLACEMENT
PART 5- PRICING FORMS****APPENDIX II - UNIT PRICES** (Due 24 hours after stipulated closing date)

All prices are to include the supply and installation of all labour, material, charges, taxes (excluding Harmonized Sales Tax), payroll, burden and profit.

ITEM	UNIT	ADD	DEDUCT
Retaining wall replacement	Per approx. 10' long section	\$	\$

**TZC T 38-2021-10 RETAINING WALL REPLACEMENT
PART 5- PRICING FORMS**

APPENDIX III - ADDITIONAL PRICES (Due 24 hours after stipulated closing date) – **NOT APPLICABLE**

(**not included** in Total Tender Price)

All prices are to include the supply and installation of all labour, material, taxes (excluding Harmonized Sales Tax), charges, payroll, burden and profit.

ITEM	DESCRIPTION	PRICE

* For each item, insert amount in the appropriate column to indicate whether the price change will result in an increase in, or a reduction of, the Total Tender Price.

**TZC T 38-2021-10 RETAINING WALL REPLACEMENT
PART 5- PRICING FORMS**

APPENDIX IV- ALTERNATIVE PRICES – NOT APPLICABLE

(**not included** in Total Tender Price)

All prices are to include the supply and installation of all labour, material, taxes (excluding Harmonized Sales Tax), charges, payroll, burden and profit.

Item	Description	Increase or Reduction From Total Tender Price
-------------	--------------------	--

* For each item, insert amount in the appropriate column to indicate whether the price change will result in an increase in, or a reduction of, the Total Tender Price.

**TZC T 38-2021-10 RETAINING WALL REPLACEMENT
PART 5- PRICING FORMS**

APPENDIX V - *UNSOLICITED ALTERNATIVES (Due 24 hours after stipulated closing date IF APPLICABLE)
(prices not used for Total Tender Price)

All alternatives must conform to the requirements of Section 01 25 00 – Product Substitution Procedures.

All prices are to include the supply and installation of all labour, material, taxes (including Harmonized Sales Tax), charges, payroll, burden and profit.

Number of Item	Description of Item	Change in Total Tender Price Substituted in Work	
		Increase	Reduction
